





LUCE 1987.

"Il successo di un prodotto risiede nei suoi dettagli distintivi, mentre la narrativa di un brand si costruisce attraverso la sua storia unica. ITALIAN DESIGN LIGHTING incarna questa filosofia, trasmettendo con maestria oltre 35 anni di esperienza nel mondo dell'illuminazione. Ogni elemento riflette l'impegno per la perfezione e contribuisce a tessere la trama di un marchio che illumina il percorso del design italiano con dedizione e competenza."

"The success of a product lies in its distinctive details, while a brand's narrative is built through its unique history. ITALIAN DESIGN LIGHTING embodies this philosophy, skillfully conveying over 35 years of experience in the world of lighting. Each element reflects a commitment to perfection and contributes to weaving the narrative of a brand that illuminates the path of Italian design with dedication and expertise."



IDL
LUCE1987.



italian design lighting

La nostra storia affonda le radici nel lontano 1987, quando Feltrin Lino e Antonio Piva fondarono l'azienda a Fanzolo di Vedelago. Da quel momento, l'innovazione è stata il nostro credo, e abbiamo dedicato il nostro impegno a creare lampade con design esclusivo e forme diverse. La nostra specialità è la produzione su misura, che ci consente di realizzare lampade uniche in praticamente ogni forma e dimensione immaginabile. Il cuore pulsante della nostra azienda risiede nel nostro ufficio tecnico all'avanguardia, dove competenze avanzate in lavorazione dei metalli e l'utilizzo di moderni metodi di produzione si uniscono per materializzare progetti complessi con attenzione ai dettagli. Essere sinonimo del Made in Italy di alta qualità e design originale è ciò a cui aspiriamo ogni giorno. Dopo la prematura scomparsa di Antonio Piva nel 2012 Cristian Feltrin, l'unico Designer e attuale direttore artistico della fabbrica IDL si è impegnata in una costante ricerca di nuove idee e materiali innovativi. Questa ricerca incessante è il cuore della nostra azienda, guidata dalla volontà di rispondere alla crescente domanda di prodotti unici nel loro genere. Siamo orgogliosi di essere un marchio che si distingue per l'eccellenza, portando avanti la tradizione di IDL con passione e dedizione. La nostra storia continua a evolversi, alimentata dalla voglia di creare illuminazione che non solo soddisfi le esigenze pratiche, ma che rappresenti anche un'opera d'arte luminosa.

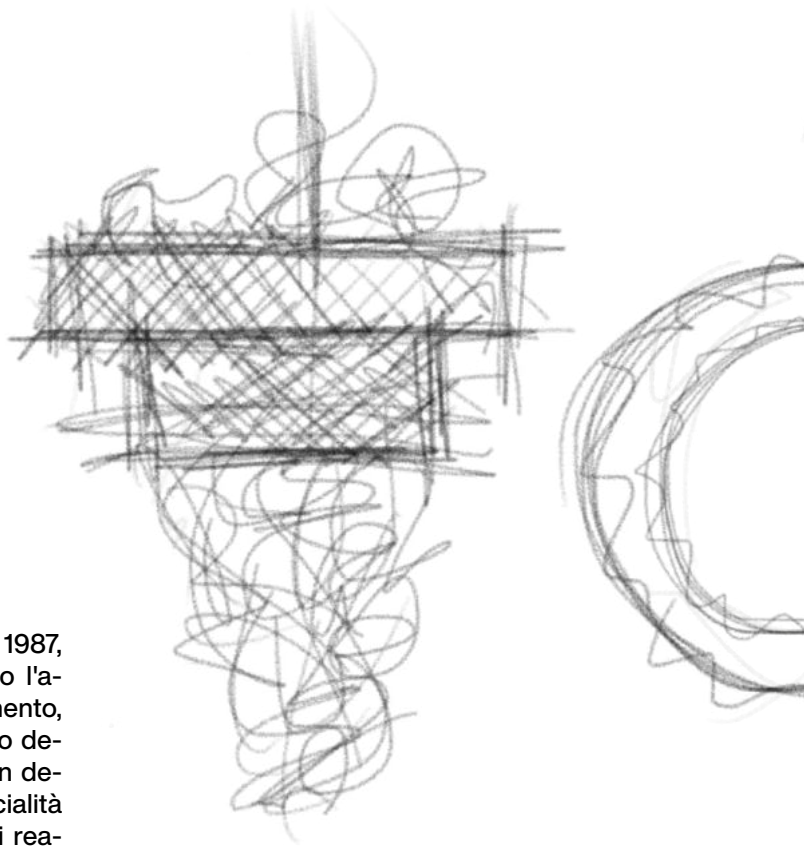

Our history dates back to the distant year of 1987 when Feltrin Lino and Antonio Piva founded the company in Fanzolo di Vedelago. Since then, innovation has been our creed, and we have dedicated our efforts to creating lamps with exclusive designs and diverse forms. Our specialty lies in custom production, allowing us to craft unique lamps in practically every imaginable shape and size. The heartbeat of our company resides in our cutting-edge technical office, where advanced skills in metalworking and the use of modern production methods come together to bring complex projects to life with meticulous attention to detail. Being synonymous with high-quality Made in Italy and original design is what we aspire to every day. Following the untimely passing of Antonio Piva in 2012 Cristian Feltrin, the only Designer and current artistic director of the IDL factory committed himself myself to a constant search for new ideas and innovative materials. This relentless pursuit is the essence of our company, driven by the desire to meet the growing demand for one-of-a-kind products. We take pride in being a brand distinguished by excellence, carrying forward the tradition of IDL with passion and dedication. Our story continues to evolve, fueled by the desire to create lighting that not only meets practical needs but also represents a luminous work of art.







Ogni lampada che esce dalla nostra fabbrica porta con sé l'impronta della qualità e dell'autenticità. Ogni nostro prodotto è sottoposto a scrupolosi test di qualità, e quando vedete il marchio "IDL" su di esso, potete essere certi che state acquistando un'opera originale, completamente concepita e prodotta in Italia. La nostra attenzione ai dettagli va oltre il design, estendendosi alle finiture metalliche di alta qualità che rendono le nostre lampade adatte anche agli ambienti umidi, garantendo durata nel tempo e resistenza. La gamma dei prodotti IDL è diversificata e abbraccia molteplici stili. Dalle collezioni caratterizzate da design raffinato, linee morbide ed eleganti con dettagli attentamente selezionati, fino alle finiture costose in metallo, ai dettagli artigianali, al pregiato vetro di Murano e alle collezioni dalle forme semplici e rigorose. Quest'ultime presentano linee pulite, combinate con una razionalità e funzionalità esemplari. Con oltre 30 anni di esperienza e il supporto del nostro competente staff tecnico, ci distinguiamo nella progettazione, sviluppo e realizzazione di apparecchi di illuminazione personalizzati. Circa la metà della nostra produzione è dedicata a modelli non convenzionali, dimostrando la nostra flessibilità e la capacità di adattarci alle esigenze specifiche dei nostri clienti. Siamo qui per illuminare le vostre idee, portando luce e creatività in ogni angolo della vostra vita.

IDL
LUCE1987.

Every lamp that leaves our factory carries the mark of quality and authenticity. Each of our products undergoes meticulous quality tests, and when you see the "IDL" brand on it, you can be sure that you are purchasing an original work, entirely conceived and produced in Italy. Our attention to detail goes beyond design, extending to high-quality metal finishes that make our lamps suitable even for humid environments, ensuring durability and resistance over time. The range of IDL products is diverse, encompassing various styles. From collections characterized by refined design, soft and elegant lines with carefully selected details, to costly metal finishes, artisanal details, precious Murano glass, and collections with simple and rigorous forms. The latter feature clean lines combined with exemplary rationality and functionality. With over 30 years of experience and the support of our skilled technical staff, we excel in the design, development, and production of custom lighting fixtures. Approximately half of our production is dedicated to unconventional models, showcasing our flexibility and ability to adapt to the specific needs of our clients. We are here to illuminate your ideas, bringing light and creativity to every corner of your life.



index



acropora
page 84-95



amalfi
page 352-359



angel
page 282-287



artic
page 112-127



bamboo
page 360-381



cesare
page 218-223



charme
page 308-319



chrysalis
page 192-207



corten
page 332-351



crystal blade
page 256-267



crystal moon
page 288-295



crystal rock
page 324-331



crystalline
page 234-243



diamante
page 244-249



dp
page 18-31



eklè
page 58-83



elite
page 142-151



floritude
page 250-255



flower miu
page 102-111



grace
page 320-323



groovy
page 152-165



ice rain
page 128-141



leaves
page 208-217



marea
page 32-45



miox
page 46-57



miu
page 96-101



ninfea
page 300-307



paradise
page 268-281



roma
page 224-233



tribù
page 182-191



vanity
page 296-299



weave
page 166-181



color samples
page 14-15

668/20
668/20+16
669/20
668/24
671/3S
668/20
668/20+16
669/20
668/24

code index
page 12-13

code index

Acropora

650/1L	94 95
650/3	95
650/4A	90 95
650/5L	93 95
650/8PF	95
650/20	85 87 91 95
650/28	89 95
651/9	95
651/9PF	95
651/14	95
651/15P	92 95
651/60	95

Amalfi

478/35/E	359
478/35PF/E	359
478/50/E	359
478/50PF/E	359
478/72/E	359
478/72PF/E	359
478/90/E	359
478/90PF/E	359
482/35	359
482/35PF	358 359
482/50	353 355 359
482/50PF	358 359
482/72	353 354 357 359
482/72PF	359
482/90	356 359
482/90PF	359

Angel

653/1AP	283 287
653/1LG	286 287
653/1LP	287
653/1SG	284 287
653/1SP	284 285 287
653/2+1S	287
653/6+6	283 287

Artic

641/90	115 127
642/3ADX	127
642/3ASX	127
642/50	127
642/60PF	122 126
642/70	114 127
642/90	113 127
642/90PF	126
642/115	126
642/150	121 126
642/L	124 127
643/4	121 127
643/10	119 126
643/12	116 126

Bamboo

423/1A	375 381
423/1L	370 381
423/1S	369 380
423/2ADX	374 381
423/2ASX	374 381
423/3	380
423/3A	363 365 381
423/3L	370 381
423/3P	377 381
423/3PF	380
423/6	367 380
423/6PF	371 380
423/8	364 380
423/8PF	380
423/10PF	368 380
423/12	362 380
423/12PF	380
423/35	373 381
423/66	372 381
423B/1LG	376 381
423B/1LP	376 381
423B/4P	379 381
423B/5P	379 381
496/8	366 380
497/8	360 361 380
497/8+8	380
497/12	361 380

Cesare

632/50	219 223
632/76	219 222 223
632/110	219 221 223

Charme

600/1LG	309 319
600/1LM	311 319
600/1LP	309 319
601/1LG	314 319
601/1LM	312 313 315 319
600/7P	316 319
600/9P	316 319
600/13P	317 319

Chrysalis

448/1LG	204 207
448/3	206
448/3ADX	202 207
448/3ASX	202 207
448/3L	203 207
448/3PF	198 207
448/3+3	206
448/3+3PF	207
448/5	206
448/5L	203 207
448/5PF	207

448/5+3	193 206
448/5+3PF	198 207
448/6	206
448/6P	207
448/6+3	193 206
448/6+5P	205 207
448/8	199 206
448/8PF	207
448/8SLED	194 206
448/8+3	206
448/8+3PF	207
448/84PF	197 207
448/27	201 206
448/2000LED	196 206
448/SPOT	207

Corten

468/1LED	350
468/1PFLED	341 351
468/2LED	334 350
468/35/E	350
468/35PF/E	350
468/50/E	350
468/50PF/E	339 350
468/72/E	339 350
468/72PF/E	350
468/120LED	336 350
468/P	348 351
469/1L	349 351
469/3A	343 351
469/3AG	342 351
469/6	335 350
469/6PF	340 351
469/6PFG	351
469/120	350
509/3L	346 351
509/4	333 350
509/4A-G	344 351
509/4A-M	351
509/4L	346 347 351
509/6	332 350
509/8	333 350
509/16A-G	351
509/16A-M	345 351

Crystal Blade

512/1A	257 267
512/1L	266 267
512/2A	261 267
512/2L	266 267
512/3A	263 267
512/5P	265 267
512/5SG	260 267
512/6	264 267
512/6+3	256 267

512/8	259 267
512/120	258 267

Crystal Moon

475/1AG-PFG	291 295
475/1AP-PFP	291 295
475/1L	294 295
475/1SG	292 295
475/1SP	295
475/12	289 295
475/12PF	290 295

Crystal Rock

476/2L	331
476/3	331
476/3L	330 331
476/4	325 326 327 331
476/4A	329 331
476/4PF	328 331

Crystalline

493/2A	242 243
493/3L	242 243
493/6	235 239 243
493/6P	242 243
493/10	240 243
493/10PF	241 243
493/16	243
493/16+16	238 243
493/80PF	243
494/12	237 243
494/24	243

Diamante

628/50	245 249
628/70	246 247 248 249
628/90	245 249
628/A	249
628/L	249

Dp

672/1A	29 31
672/1L	30 31
672/2A	28 31
672/3	24 31
672/3L	30 31
672/5	24 31
672/5P	27 31
672/9	31
672/9PF	25 31
672/15	19 20 31
672/15PF	31
672/16	31
672/16P	26 31
673/9	23 31
673/12	22 31

Eklè	
668/1LM	75 83
668/1LP	75 83
668/1P	77 83
668/2A	72 83
668/3L	76 83
668/4A	72 83
668/6	67 82
668/6A	83
668/6P	78 83
668/12	68 82
668/12P	81 83
668/12PF	73 83
668/16	82
668/16PF	82
668/20	63 82
668/20+16	59 82
668/24	60 82
669/20	65 82
670/16PF	82
670/20	71 82
671/3S	62 82
Elite	
596/2+1A	149 151
596/4+1	150 151
596/8+1	143 151
596/8+1PF	145 151
596/28+3	151
596/34+3	146 147 151
596/41+6	151
596/150	148 151
Floritude	
664/5	254 255
664/9	251 253 255
Flower Miu	
655/1A	111
655/1SG	111
655/1SM	111
655/1SP	111
655/2A	108 111
655/3P	110 111
655/3+3	111
655/4	107 111
655/7	106 111
655/9SL	105 111
655/1LG	111
655/LP	108 111
658/1SG	103 111
658/1SM	103 111
658/1SP	103 111
Roma	
359/1L	232 233

359/1SP	233
359/2A	230 233
359/4A	230 233
359/5R	227 233
359/5SP	228 233
359/14	225 233
359/22	226 233
359/42	233
Grace	
530/2A	322 323
530/6	321 323
530/6+3	321 323
530/10+5	323
Groovy	
463/1A	157 163 165
463/1L	161 165
463/1P	153 165
463/2AP	165
463/6	160 165
463/8PF	162 165
463/10	159 165
463/10PF	165
463/12	158 165
464/6	156 165
464/12	153 154 164 165
Ice Rain	
507/3A	133 141
507/4L	140 141
507/6A	133 141
507/6P	139 141
507/6S	141
507/10	135 141
507/10PF	136 141
507/12	129 134 141
507/12PF	141
507/18	129 141
508/10	132 141
508/12	131 141
508/80	137 141
508/120	141
Leaves	
605/1S	217
605/5A	214 216 217
605/5PF	217
605/8	211 215 217
605/10	212 213 217
605/10PF	217
605/16	209 210 211 217
605/16PF	217
606/10	217
606/16	217

Marea	
674/3S	45
674/50	45
674/78	39 45
674/110	45
675/50	45
675/78	37 45
675/110	45
676/110	34 45
677/2L	44 45
677/3	41 45
677/5PF	43 45
677/6	40 45
677/AG	42 45
677/AP	42 45
Miox	
679/1A	55 57
679/1L	56 57
679/2	51 57
679/2A	54 57
679/6	50 57
680/1A	57
680/3	48 57
680/6	49 57
680/8	47 57
680/10	52 57
Miu	
656/1SG	99 101
656/1SM	101
656/1SP	99 101
656/2A	100 101
656/3A	101
656/7SL	97 101
656/9	98 101
657/1SG	101
657/1SM	101
657/1SP	101
Ninfea	
436/4+1A	305 307
436/5L	306 307
436/5P	303 307
436/10+1	307
436/10+1PF	304 307
436/18+1	301 302 307
436/18+1PF	307
Paradise	
430/1L	277 281
430/1P	280 281
430/2ADX	275 281
430/2ASX	271 281
430/4A	275 281
430/20	274 281

430/42	281
430/42PF	276 281
430/62	269 270 272 281
430/65PF	281
430/90PF	278 279 281
430/100	273 281
430/120	281
430/120PF	281
Roma	
359/1L	232 233
359/1SP	233
359/2A	230 233
359/4A	230 233
359/5R	227 233
359/5SP	228 233
359/14	225 233
359/22	226 233
359/42	233
Tribù	
660/1A	189 191
660/2A	184 189 191
660/10	183 191
661/1A	187 191
661/2A	187 190 191
661/2L	185 191
Vanity	
584/1L	297 299
585/1L	298 299
Weave	
511/1L	178 181
511/2A	176 181
511/2L	181
511/3	173 180
511/3L	181
511/4	173 180
511/4L	177 181
511/6	172 180
513/3A	181
513/6	180
513/6PF	174 181
513/8	167 180
513/8PF	181
513/12	167 180
513/16	180
513/26	169 180
514/6	170 180
590/1L	179 181
591/1L	179 181

color samples

finiture verniciate painted finishes



Bianco velluto
Velvet white

Nero velluto
Velvet black

Avorio lucido
Soft ivory

Quarzo brillante
Shiny quartz

Sabbia brillante
Shiny sand

Grigio Danimarca
Grey Denmark

finiture a foglia leaf finishes



Foglia oro
Gold leaf

Foglia argento
Silver leaf

Foglia nera
Black leaf

finiture corten corten finishes

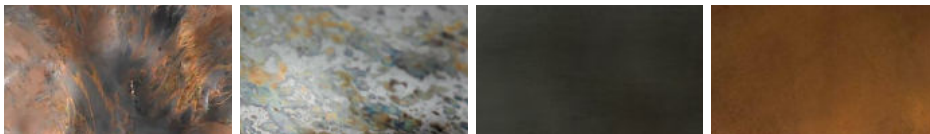

Marrone Corten
Brown Corten

Argento Corten
Silver Corten

Brunito Corten
Burnished Corten

Ruggine
Rusty

finiture galvaniche galvanic finishes

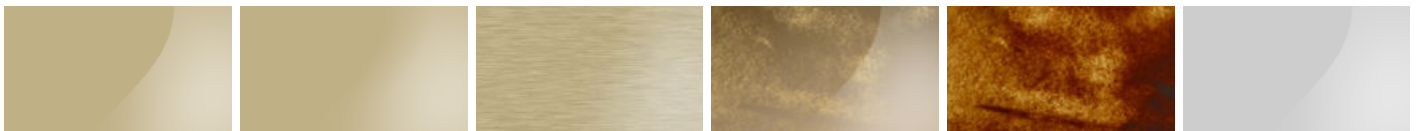

Oro chiaro
Light gold

Oro chiaro opaco
Matt light gold

Oro chiaro spazzolato
Brushed light gold

Oro antico lucido
Glossy antique gold

Oro antico opaco
Matt antique gold

Nichel bianco
Pure steel

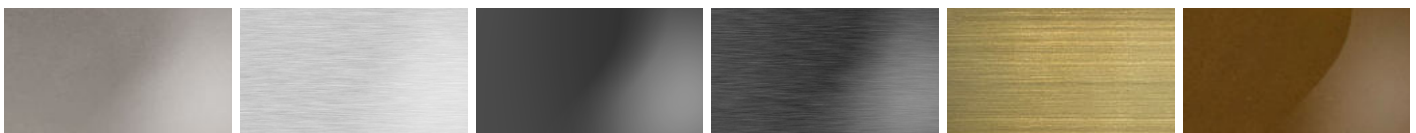

Nichel opaco
Matt nickel

Nichel opaco spazzolato
Brushed matt nickel

Nichel nero
Black nickel

Nichel nero spazzolato
Brushed black nickel

Ottone brunito spazzolato
Brushed burnished brass

Bronzo lucido
Glossy bronze



Bronzo opaco
Matt bronze

Bronzo spazzolato
Brushed bronze

Cromo
Chrome

Rame
Copper

Black aubergine

paralume in chinette chinette lampshade



Chinette avorio
Ivory chinette

Chinette tortora
Dove grey chinette

Paralume in lamè lamè lampshade



Lamè argento
Silver lamè

Lamè oro
Gold lamè

Paralume in juta jute lampshade

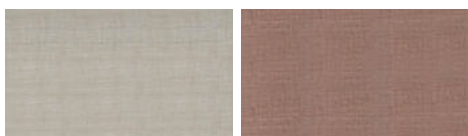

Juta chiaro
Light jute

Juta scuro
Dark jute

Paralume in plissè plissè lampshade

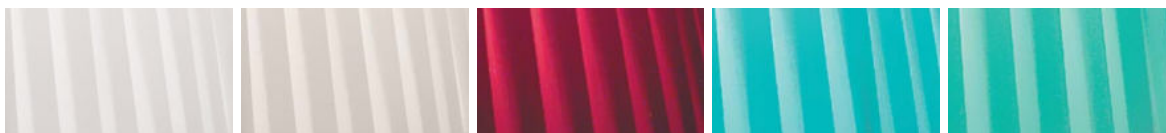

Plissè bianco
White plissè

Plissè avorio
Ivory plissè

Plissè rosso
Red plissè

Plissè blu
Blue plissè

Plissè verde
Green plissè

La finitura **Brunito Corten**, **Marrone Corten**, **Argento Corten**, **Ruggine**, **Oro Antico Opaco**, **Oro Antico Lucido** è un procedimento di ossidazione naturale. La realizzazione di tale processo è influenzata dal livello di umidità, dalla temperatura esterna e da altre variabili ambientali. La mano dell'uomo e la specifica lavorazione sono il valore aggiunto che testimonia l'autentico 'Made in Italy'. Come tutte le opere dove il procedimento non è meccanico ma artigianale le eventuali variazioni di colore non sono da considerarsi un difetto ma una testimonianza dell'unicità del prodotto. Le finiture Corten e Oro antico rendono quindi il prodotto unico e irripetibile. Le foto presenti nel nostro catalogo costituiscono solo un'identificazione del tipo di prodotto e non rappresentano un campione degli stessi.

Nella tutela del cliente, IDL EXPORT SRL si riserva il diritto di apportare modifiche e/o migliorie ai prodotti illustrati nel presente catalogo senza alcun obbligo di preavviso. Ogni nostro prodotto viene etichettato secondo le normative vigenti e in esso viene applicato il tagliando di autenticità **Made in Italy**. Qualsiasi lieve variazione di tonalità imperfezione nei vetri non costituiscono un difetto, ma contribuiscono ad esaltarne la complessa lavorazione artigianale.

TUTELA SUI DIRITTI D'AUTORE, LEGGE 22/4/1941 N°633, LEGGE 14/12/1942 N°1485 PROIBITA OGNI RIPRODUZIONE ANCHE PARZIALE

The finishes **Burnished Corten**, **Brown Corten**, **Silver Corten**, **Rust**, **Matt antique gold**, **Glossy antique gold** are the result of a procedure of natural oxidation. The procedure is every time affected by the percentage of humidity in the air, by the external temperature and by other environmental variables. Hands of man and a special processing are a value added, which is evidence of the real 'Made in Italy'. As in all works where the procedure is not mechanical but handcrafted, variations are possible, but they must not be considered as a defect, but rather as a proof of the uniqueness of the product. The Corten and Antique gold finishes makes the product as unique, since every results is not reproducible in identical way. The pictures of our catalogues are only an example of the kind of the product, but they cannot be considered strictly as samples of them, since the result can be different.

For our customer protection, IDL EXPORT SRL reserves the right to modify and / or improve to the products shown in this catalogue without notice. Each product is labeled according to the regulations and it is applied authenticity coupon **Made in Italy**. Any slight variation in color and imperfections in the glasses is not a defect but a contribution to enhance the complex craftsmanship.

SAFEGUARDED BY THE LAW ON COPYRIGHT





the collections

dp

DESIGN CRISTIAN FELTRIN















1 672/3
2 672/5

sospensione | suspension



672/9PF
plafoniera | ceiling lamp





672/5P
lampada da terra | floor lamp





672/1A
applique | wall bracket



1

2

1 672/1L
2 672/3L
lampada da tavolo | table lamp

La collezione è disponibile nei seguenti abbinamenti di finiture:
 - telaio in metallo quarzo brillante con particolari bronzo opaco
 - telaio in metallo sabbia brillante con particolari oro chiaro opaco
 - telaio in ottone brunito spazzolato
 I vetri diffusori sono in vetro di Murano in graniglia in colore bianco opaco o bronzo opaco.

The collection is available in the following combinations of the finishes:
 - metal frame shiny quartz with matt bronze details
 - metal frame shiny sand with matt light gold details
 - metal frame brushed burnished brass
 Matt white or matt bronze Murano glass diffusers with grit.

672/9PF
 9 x LED 2 W
 1800 lumen - 3000K
 CE ⊕ ▽

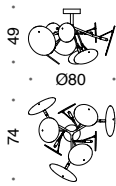

A

672/15
 15 x LED 2 W
 3000 lumen - 3000K
 CE ⊕ ▽

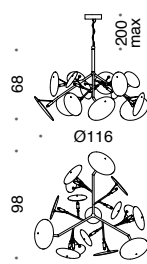

B - C

672/16
 16 x LED 2 W
 3200 lumen - 3000K
 CE ⊕ ▽

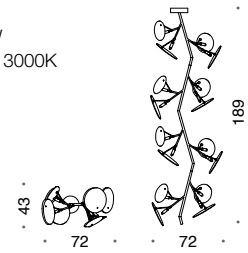

B - C

673/9
 9 x LED 2 W
 1800 lumen - 3000K
 CE ⊕ ▽

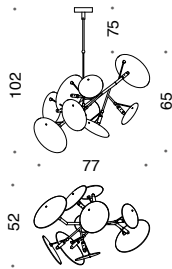

B - C

673/12
 12 x LED 2 W
 2400 lumen - 3000K
 CE ⊕ ▽

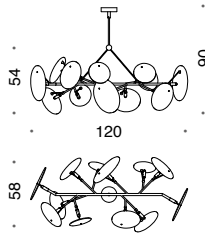

B - C

672/5
 5 x LED 2 W
 1000 lumen - 3000K
 CE ⊕ ▽

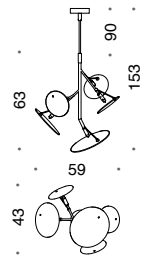

A

672/3
 3 x LED 2 W
 600 lumen - 3000K
 CE ⊕ ▽

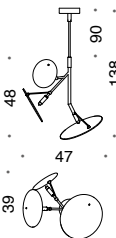

A

672/15PF
 15 x LED 2 W
 3000 lumen - 3000K
 CE ⊕ ▽

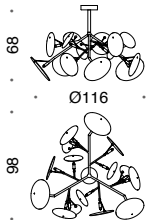

B - C

672/9
 9 x LED 2 W
 1800 lumen - 3000K
 CE ⊕ ▽

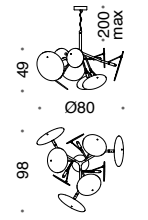

A

672/2A
 2 x LED 2 W
 400 lumen - 3000K
 CE ⊕ ▽

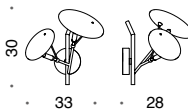

D

672/1A
 1 x LED 2 W
 200 lumen - 3000K
 CE ⊕ ▽

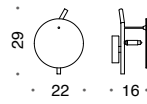

D

672/1L
 1 x LED 2 W
 200 lumen - 3000K
 CE ⊕ ▽

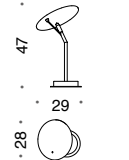

A

672/3L
 3 x LED 2 W
 600 lumen - 3000K
 CE ⊕ ▽

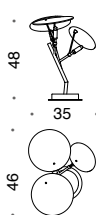

A

672/5P
 5 x LED 2 W
 1000 lumen - 3000K
 CE ⊕ ▽

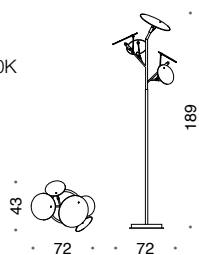

A

672/16P
 16 x LED 2 W
 3200 lumen - 3000K
 CE ⊕ ▽

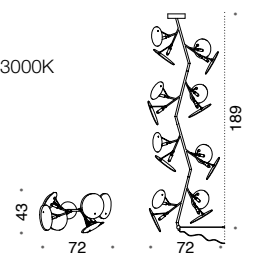

B - C



marea

DESIGN **CRISTIAN FELTRIN**



















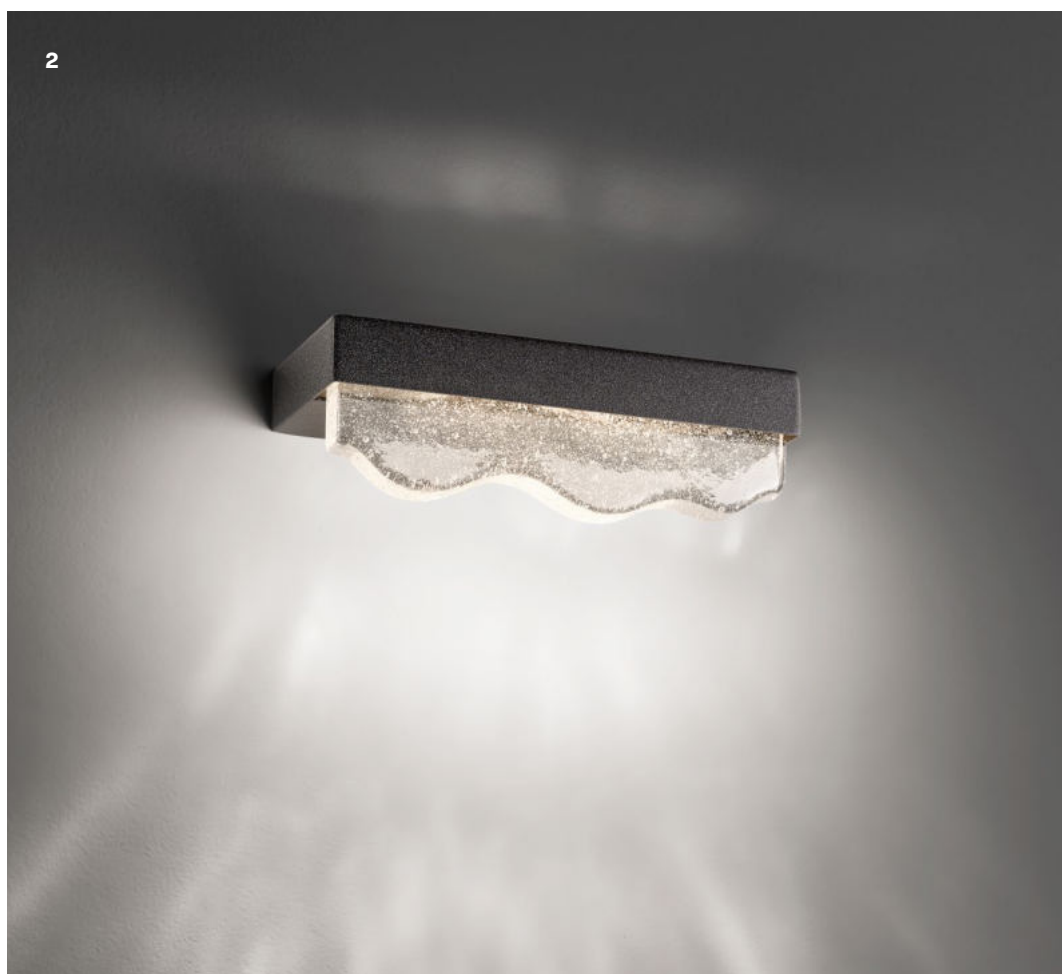

1 **677/AG**
2 **677/AP**
applique | wall bracket





marea

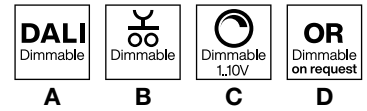

DESIGN **CRISTIAN FELTRIN**

Il telaio in metallo è disponibile nelle seguenti finiture:

- sabbia brillante
- grigio Danimarca
- oro chiaro spazzolato opaco

Il vetro diffusore è in vetro di Murano pulegoso trasparente.

The metal frame is available in the following finishes:

- shiny sand
- grey Denmark
- brushed matt light gold

Transparent Pulegoso blown Murano glass diffusers.

675/110

Strip LED 47 W
6110 lumen - 3000K
CE ⊕ ▽

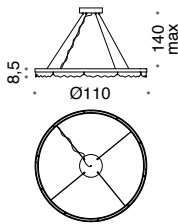

C

675/78

Strip LED 33 W
4290 lumen - 3000K
CE ⊕ ▽

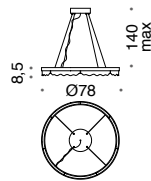

C

675/50

Strip LED 20 W
2600 lumen - 3000K
CE ⊕ ▽

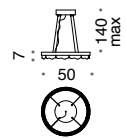

C

676/110

Strip LED 100 W
13000 lumen - 3000K
CE ⊕ ▽

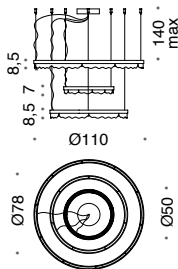

C

674/110

Strip LED 47 W
6110 lumen - 3000K
CE ⊕ ▽

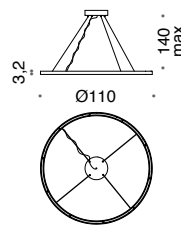

C

674/78

Strip LED 33 W
4290 lumen - 3000K
CE ⊕ ▽

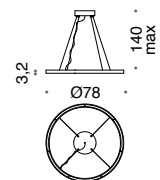

C

674/50

Strip LED 20 W
2600 lumen - 3000K
CE ⊕ ▽

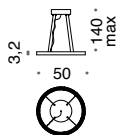

C

674/3S

Strip LED 100 W
13000 lumen - 3000K
CE ⊕ ▽

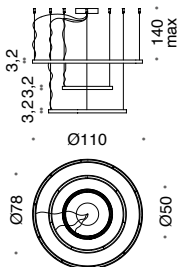

C

677/6

Strip LED 40 W
2420 lumen - 3000K
CE ⊕ ▽

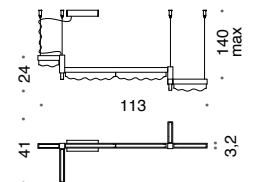

B - C

677/5PF

Strip LED 30 W
1815 lumen - 3000K
CE ⊕ ▽

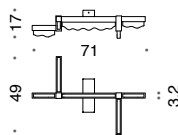

B - C

677/3

Strip LED 20 W
1210 lumen - 3000K
CE ⊕ ▽

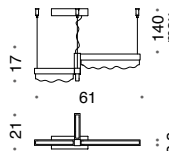

B - C

677/2L

Strip LED 20 W
1210 lumen - 3000K
CE ⊕ ▽

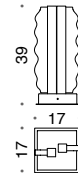

B - C

677/AG

Strip LED 10 W
605 lumen - 3000K
CE ⊕ ▽

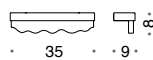

D

677/AP

Strip LED 5 W
605 lumen - 3000K
CE ⊕ ▽

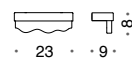

D

NOTA: Per l'installazione con altezza inferiore a 75 Cm, per motivi tecnici si consiglia di fissare i cavi d'acciaio direttamente al soffitto.

NOTE: For installation with a height lower than 75 cm, for technical reasons it is recommended to fix the steel cables directly to the ceiling.

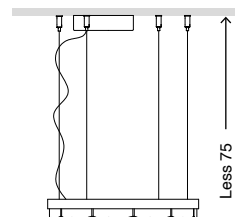



miox

DESIGN CRISTIAN FELTRIN



















679/1A
applique | wall bracket



miox

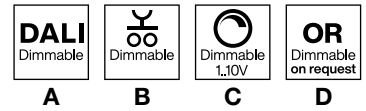

DESIGN **CRISTIAN FELTRIN**

Il telaio in metallo è disponibile nelle seguenti finiture:

- oro chiaro opaco
- nichel bianco
- nichel nero

Il vetro diffusore in vetro di Murano soffiato pulegoso trasparente.

The metal frame is available in the following finishes:

- matt light gold
- pure steel
- black nickel

Transparent Pulegoso blown Murano glass diffusers.

680/8
8 x LED 2 W
1600 lumen - 3000K
CE ⊕ ▽

B - C

679/6
6 x LED 2 W
1200 lumen - 3000K
CE ⊕ ▽

B - C

680/6
6 x LED 2 W
1200 lumen - 3000K
CE ⊕ ▽

B - C

680/3
3 x LED 2 W
600 lumen - 3000K
CE ⊕ ▽

B - C

679/2
2 x LED 2 W
400 lumen - 3000K
CE ⊕ ▽

D

680/10
10 x LED 2 W
2000 lumen - 3000K
CE ⊕ ▽

B - C

679/1L
1 x LED 2 W
200 lumen - 3000K
CE ⊕ ▽

D

679/2A
2 x LED 2 W
400 lumen - 3000K
CE ⊕ ▽

B - C

680/1A
1 x LED 2 W
200 lumen - 3000K
CE ⊕ ▽

B - C

679/1A
1 x LED 2 W
200 lumen - 3000K
CE ⊕ ▽

B - C



Dettaglio del movimento rotatorio dei bracci (+/- 30°)
Detail of the rotary movement of the arms (+/- 30°)



eklè

DESIGN **CRISTIAN FELTRIN**

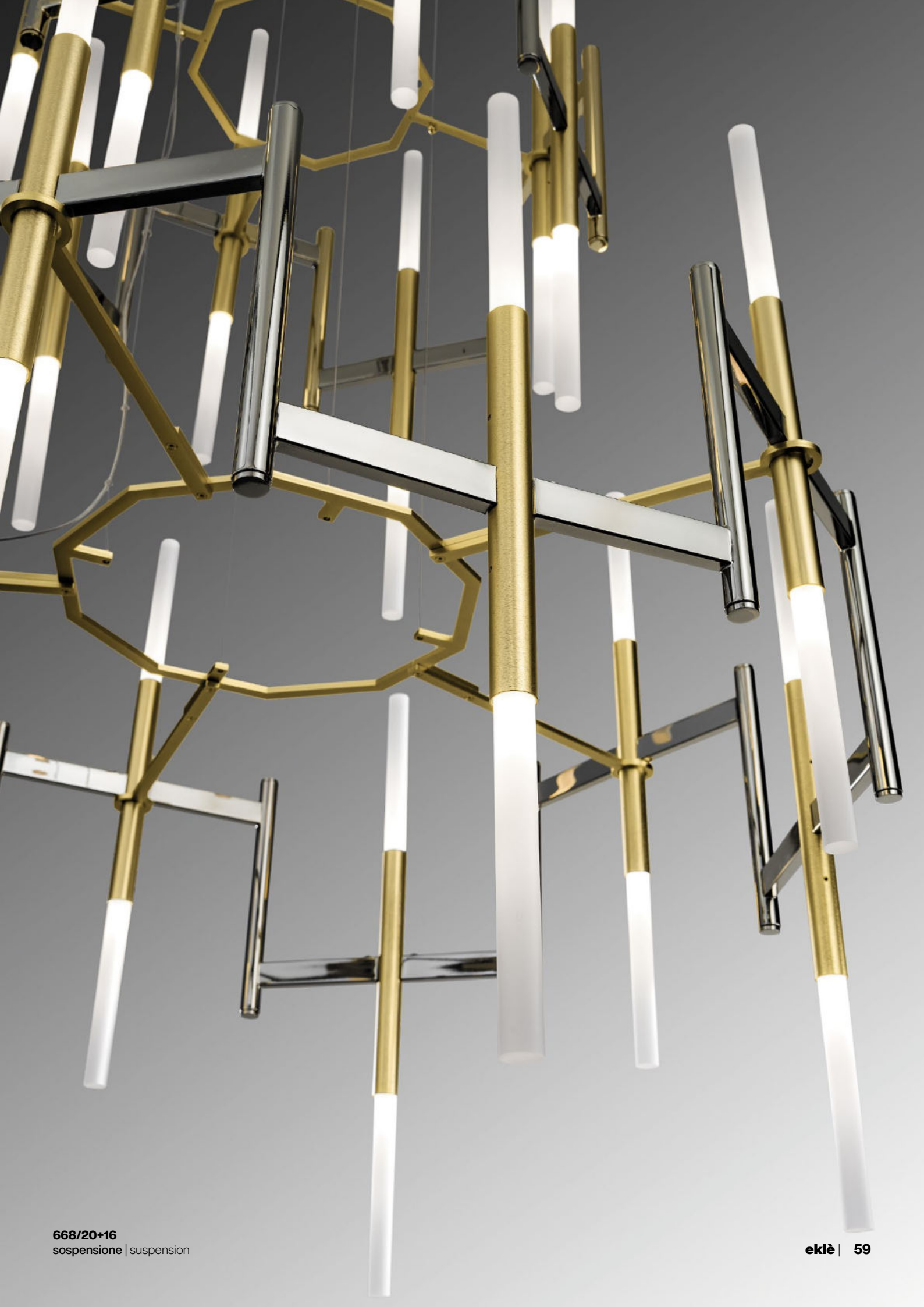

668/20+16
sospensione | suspension







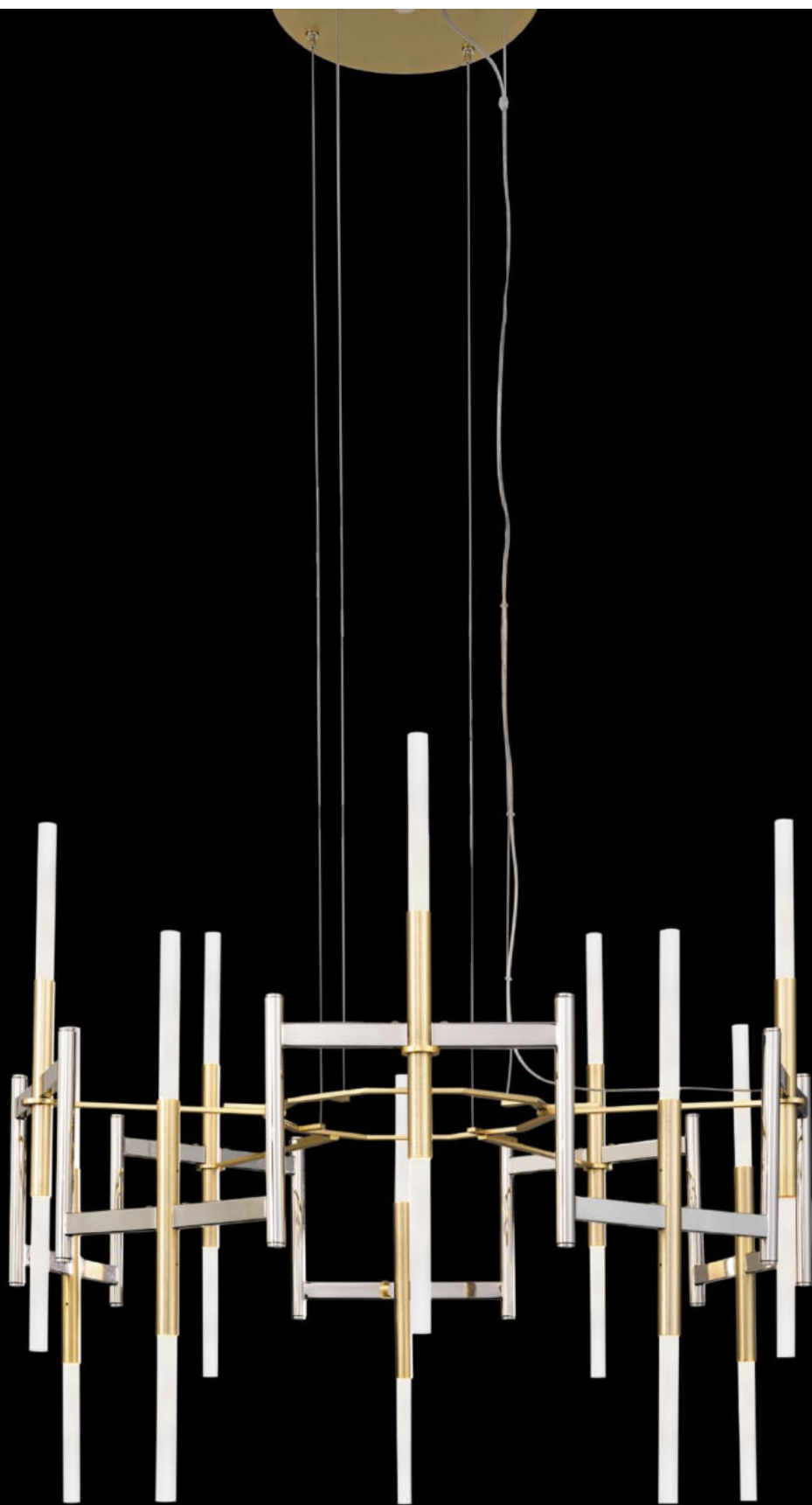



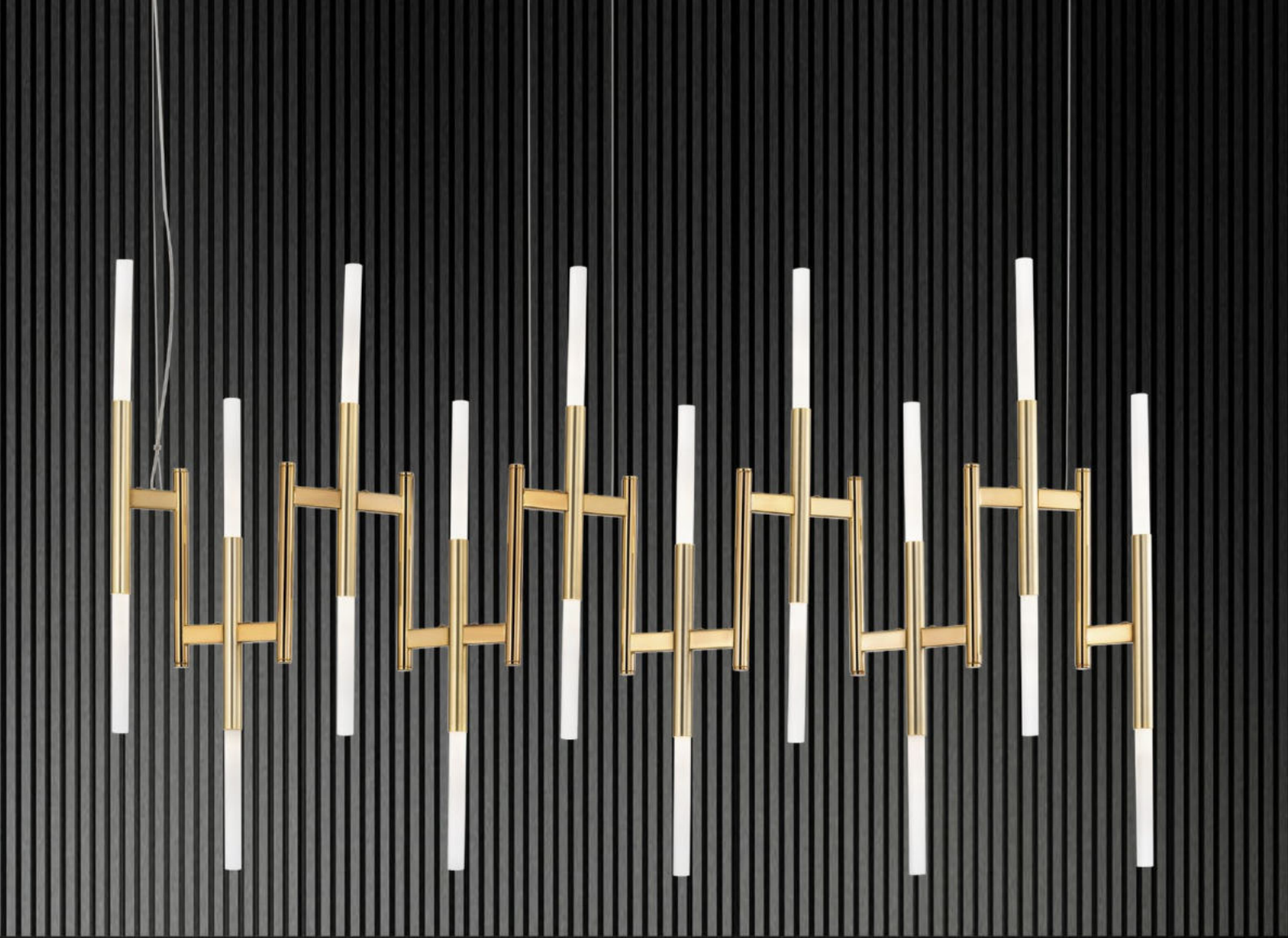

669/20
sospensione | suspension















670/20
sospensione | suspension



1



2

- 1 668/2A
 - 2 668/4A
- applique | wall bracket



668/12PF
plafoniera | ceiling lamp





1 **668/1LP**
2 **668/1LM**
lampada da tavolo | table lamp







668/1P
lampada da terra | floor lamp



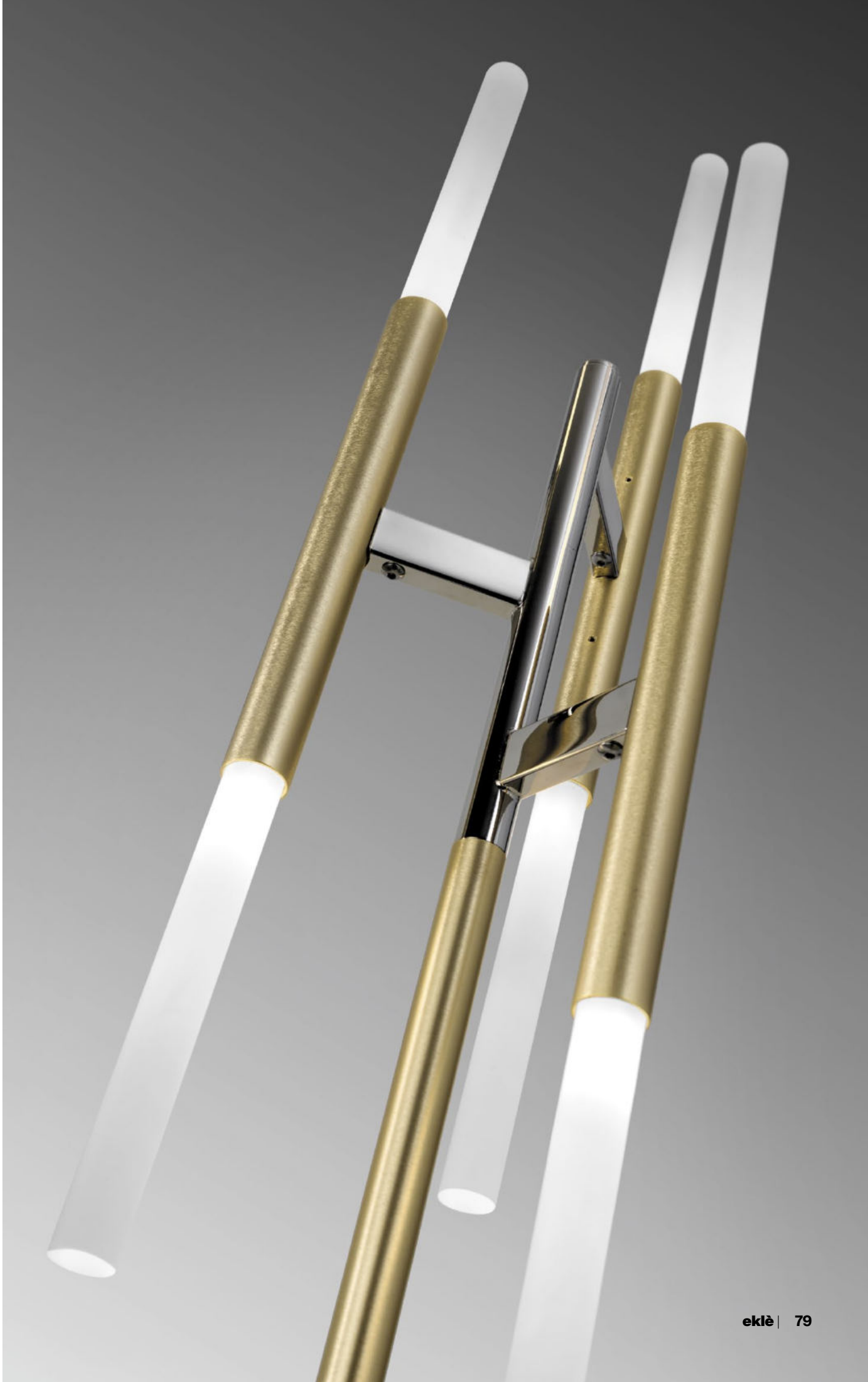





668/12P
lampada da terra | floor lamp

DESIGN **CRISTIAN FELTRIN**

Il telaio in metallo è disponibile nelle seguenti finiture:

- oro spazzolato con pure steel
- oro spazzolato con bronzo
- oro spazzolato con brunito corten
- oro spazzolato

Il diffusore è in plexiglass satinato.

Le lampade da tavolo, art. 668/1LP e art. 668/1LM sono ricaricabili tramite cavo USB incluso.

The metal frame is available in the following finishes:

- brushed gold with pure steel
- brushed gold with bronze
- brushed gold with burnished corten
- brushed gold

The diffuser is in satin plexiglass.

The table lamps, art. 668 / 1LP and art. 668 / 1LM are rechargeable via the included USB cable.

668/20+16
36 x LED 1,42W
7200 lumen - 3000K
CE ⊕ ▽

B - C

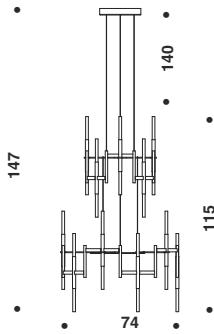

668/24
24 x LED 1,42W
4800 lumen - 3000K
CE ⊕ ▽

B - C

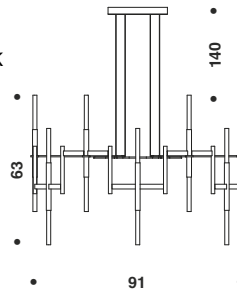

668/20
20 x LED 1,42W
4000 lumen - 3000K
CE ⊕ ▽

B - C

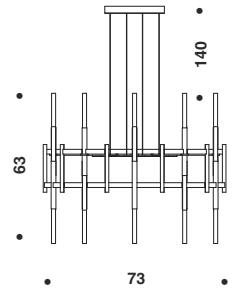

668/16
16 x LED 1,42W
3200 lumen - 3000K
CE ⊕ ▽

B - C

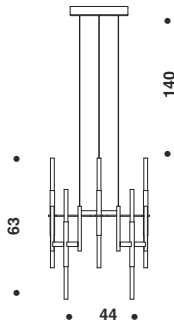

668/12
12 x LED 1,42W
2400 lumen - 3000K
CE ⊕ ▽

B - C

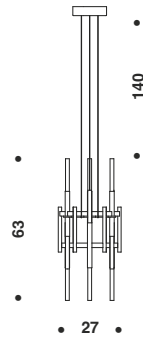

668/6
6 x LED 1,42W
1200 lumen - 3000K
CE ⊕ ▽

D

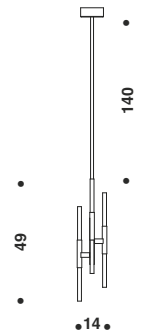

671/3S
3 x LED 1,42W
600 lumen - 3000K
CE ⊕ ▽

D

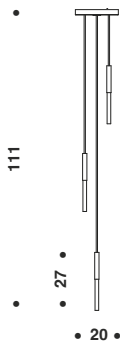

669/20
20 x LED 1,42W
4000 lumen - 3000K
CE ⊕ ▽

B - C

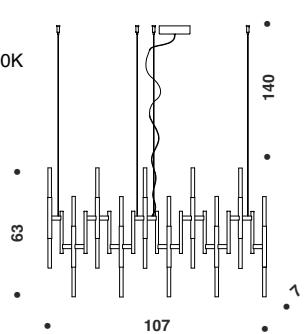

670/20
20 x LED 1,42W
4000 lumen - 3000K
CE ⊕ ▽

B - C

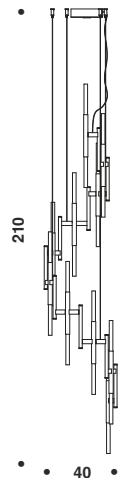

668/12PF
 12 x LED 1,42W
 2400 lumen - 3000K
 CE ⊕ ▽

D

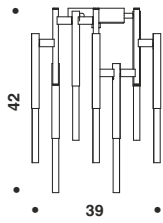

668/16PF
 16 x LED 1,42W
 3200 lumen - 3000K
 CE ⊕ ▽

B - C

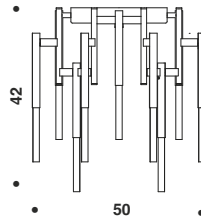

670/16PF
 16 x LED 1,42W
 3200 lumen - 3000K
 CE ⊕ ▽

B - C



668/6A
 6 x LED 1,42W
 1200 lumen - 3000K
 CE ⊕ ▽

D

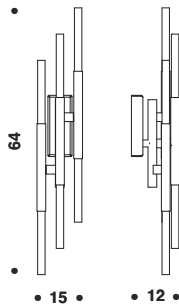

668/4A
 4 x LED 1,42W
 800 lumen - 3000K
 CE ⊕ ▽

D

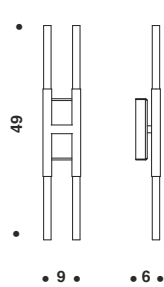

668/2A
 2 x LED 1,42W
 400 lumen - 3000K
 CE ⊕ ▽

D

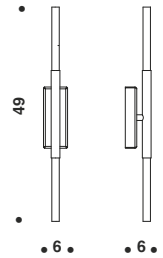

668/3L
 3 x LED 1,42W
 600 lumen - 3000K
 CE ⊕ ▽

D



668/1LM
 1 x LED 1,42W
 200 lumen - 3000K
 CE ⊕ ▽

B

**Ricaricabile with
 Micro USB**

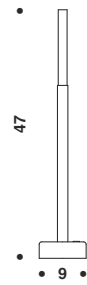

668/1LP
 1 x LED 1,42W
 200 lumen - 3000K
 CE ⊕ ▽

B

**Ricaricabile with
 Micro USB**

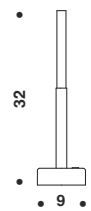

668/12P
 12 x LED 1,42W
 2400 lumen - 3000K
 CE ⊕ ▽

B - C

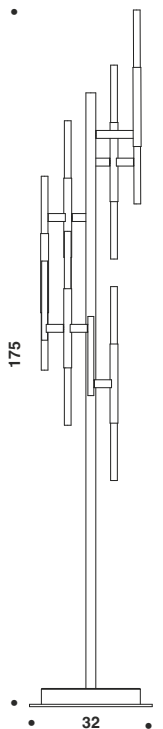

668/6P
 6 x LED 1,42W
 1200 lumen - 3000K
 CE ⊕ ▽

D

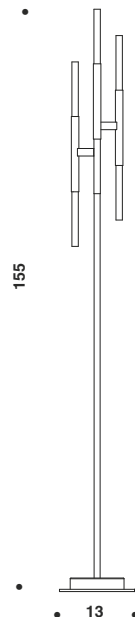

668/1P
 1 x LED 1,42W
 200 lumen - 3000K
 CE ⊕ ▽

D

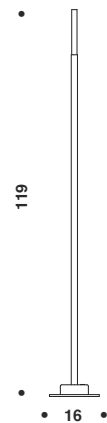



acropora

DESIGN **CRISTIAN FELTRIN**







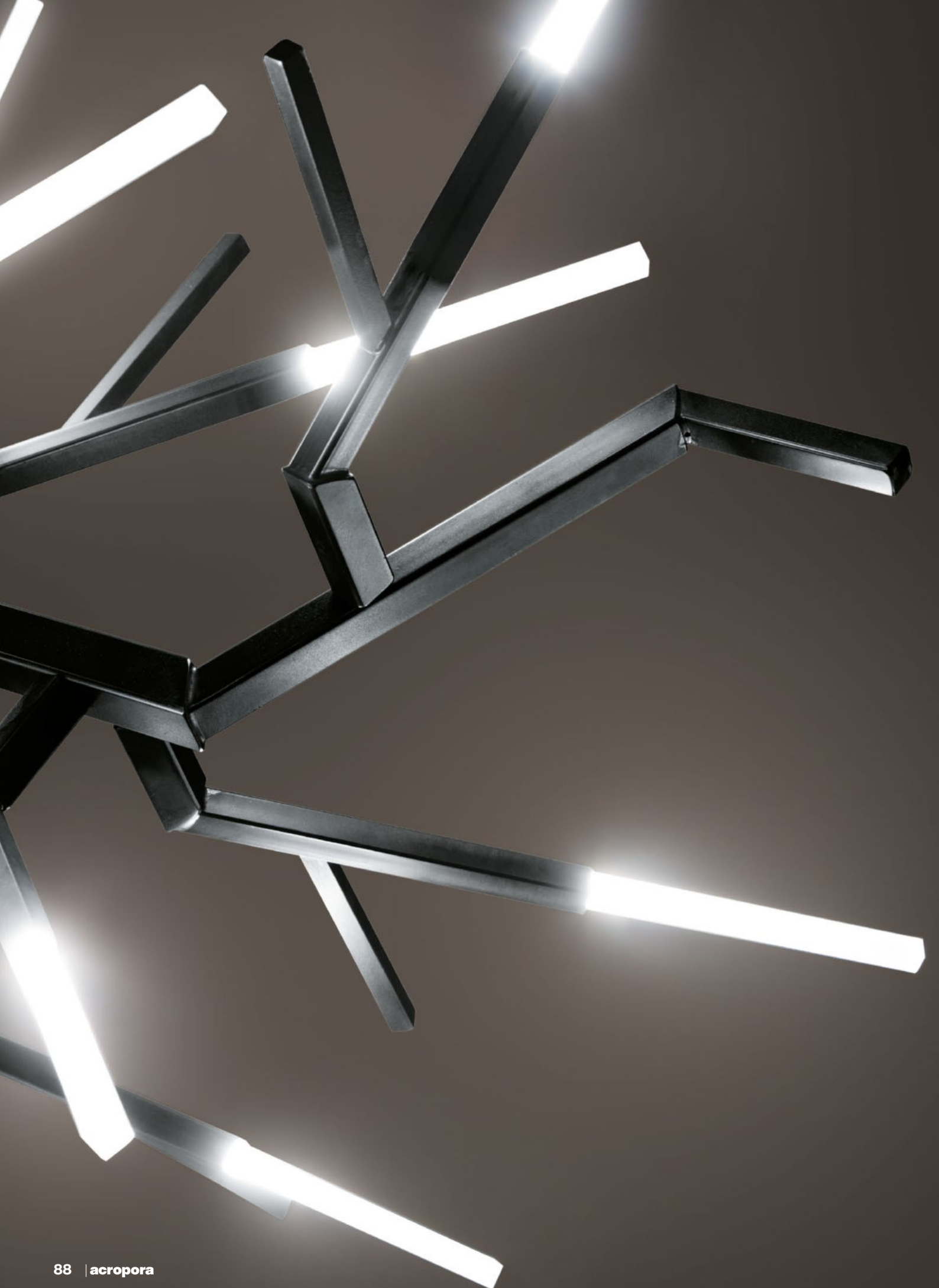







650/20
sospensione | suspension





650/5L
lampada da tavolo | table lamp

650/1L
lampada da tavolo | table lamp



acropora

DESIGN **CRISTIAN FELTRIN**

Il telaio in metallo è disponibile nelle seguenti finiture:

- pure steel
- brunito corten
- oro chiaro
- nichel nero
- oro antico lucido
- oro antico opaco
- oro opaco

Il diffusore è in plexiglass satinato.

Metal frame is available in the following finishes:

- pure steel
- burnished corten
- light gold
- black nickel
- glossy antique gold
- matt antique gold
- matt gold

Diffuser in satin plexiglas.

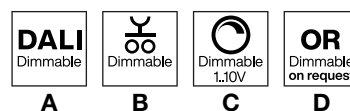

650/4A
 4 x LED 1W
 500 lumen - 3000 K
 CE ⊕ ▽

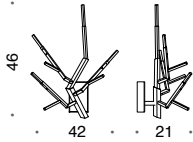

D

650/1L
 1 x LED 1W
 150 lumen - 3000 K
 CE ⊕ ▽



D

650/5L
 5 x LED 1W
 650 lumen - 3000 K
 CE ⊕ ▽

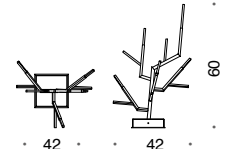

B

651/15P
 15 x LED 1W
 1900 lumen - 3000 K
 CE ⊕ ▽

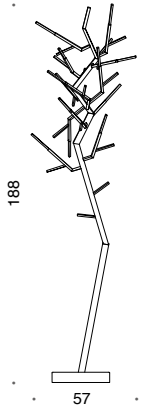

B - C

650/8PF
 8 x LED 1W
 1000 lumen - 3000 K
 CE ⊕ ▽

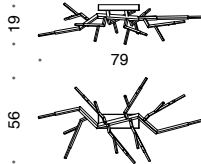

B - C

651/9PF
 9 x LED 1W
 1200 lumen - 3000 K
 CE ⊕ ▽

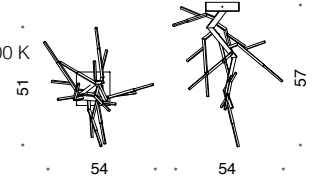

B - C

650/20
 20 x LED 1W
 2500 lumen - 3000 K
 CE ⊕ ▽

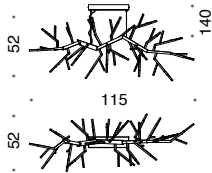

B - C

650/28
 28 x LED 1W
 3500 lumen - 3000 K
 CE ⊕ ▽

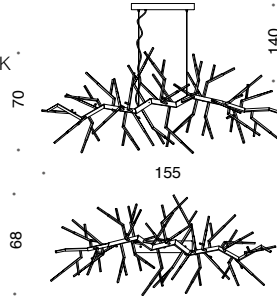

B - C

651/60
 60 x LED 1W
 8000 lumen - 3000 K
 CE ⊕ ▽

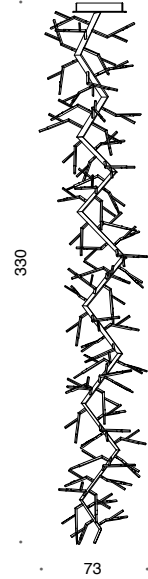

B - C

650/3
 3 x LED 1W
 450 lumen - 3000 K
 CE ⊕ ▽

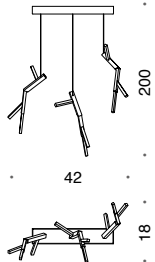

D

651/9
 9 x LED 1W
 1200 lumen - 3000 K
 CE ⊕ ▽

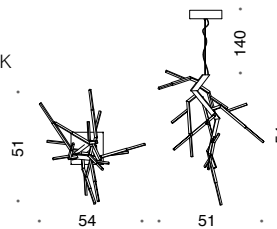

B - C

651/14
 14 x LED 1W
 1750 lumen - 3000 K
 CE ⊕ ▽

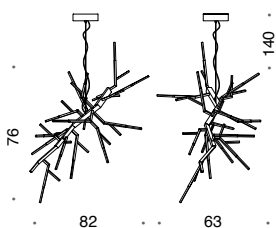

D



miu

DESIGN **CRISTIAN FELTRIN**







1

2

- 1 **656/1SP**
 - 2 **656/1SG**
- sospensione | suspension



DESIGN **CRISTIAN FELTRIN**

Il telaio in metallo è disponibile nelle seguenti finiture:

- brunito corten
- oro antico opaco
- pure steel
- oro chiaro

Sospensioni singole con attacco per soffitto in cartongesso - cod. 657

Metal frame is available in the following finishes:

- burnished corten
- matt antique gold
- pure steel
- light gold

Singular suspensions with support for drywall ceiling - art. 657

656/7SL
14 x LED 1W
1722 lumen -
3000 K



B - C

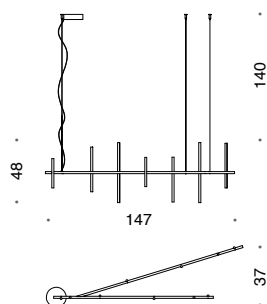

656/9
17 x LED 1W
2091 lumen -
3000 K



B - C

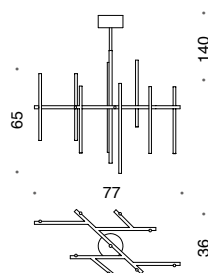

656/1SP
1 x LED 1W
123 lumen -
3000 K



D

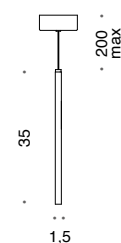

656/1SM
1 x LED 1W
123 lumen -
3000 K



D

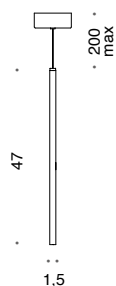

656/1SG
1 x LED 1W
123 lumen -
3000 K



D

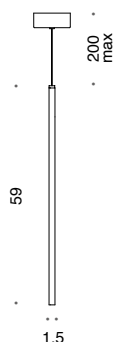

657/1SP
1 x LED 1W
123 lumen -
3000 K



D

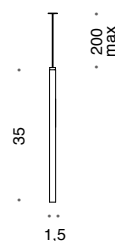

657/1SM
1 x LED 1W
123 lumen -
3000 K



D

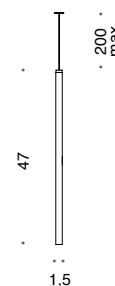

657/1SG
1 x LED 1W
123 lumen -
3000 K



D

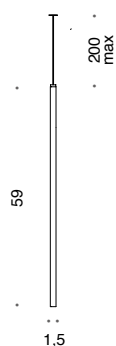

656/2A
4 x LED 1W
492 lumen -
3000 K



D

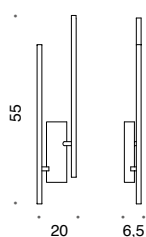

656/3A
6 x LED 1W
738 lumen -
3000 K



D

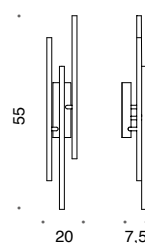



flower miu

DESIGN **CRISTIAN FELTRIN**



1



3



2

- 1 658/1SG
 - 2 658/1SM
 - 3 658/1SP
- sospensione | suspension





655/9SL
sospensione | suspension







655/2A
applique | wall bracket

655/LP
lampada da tavolo | table lamp





flower miu

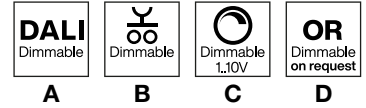

DESIGN **CRISTIAN FELTRIN**

Il telaio in metallo è disponibile nelle seguenti finiture:

- brunito corten
- oro antico opaco
- pure steel
- oro chiaro

Diffusore in vetro di Murano trasparente.

Sospensioni singole con attacco per soffitto in cartongesso - cod. 658

Metal frame is available in the following finishes:

- burnished corten
- matt antique gold
- pure steel
- light gold

Transparent Murano glass diffuser.

Singular suspensions with support for drywall ceiling - art. 658

655/9SL
27 x LED 1W
3321 lumen -
3000 K



B - C

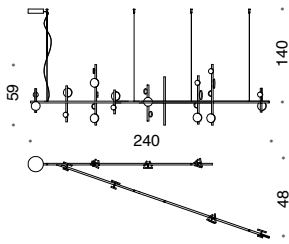

655/7
17 x LED 1W
2091 lumen -
3000 K



B - C

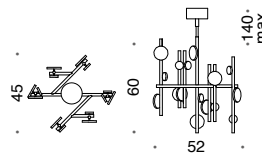

655/3+3
15 x LED 1W
1845 lumen -
3000 K



B - C

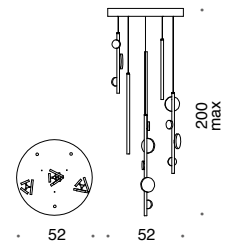

655/4
11 x LED 1W
1353 lumen -
3000 K



B - C

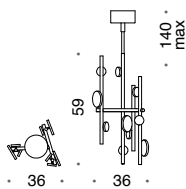

655/1SP
3 x LED 1W
369 lumen -
3000 K



D

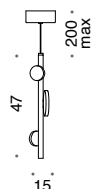

655/1SM
4 x LED 1W
492 lumen -
3000 K



D

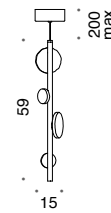

655/1SG
5 x LED 1W
615 lumen -
3000 K



D

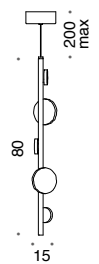

658/1SP
3 x LED 1W
369 lumen -
3000 K



D

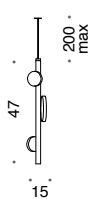

658/1SM
4 x LED 1W
492 lumen -
3000 K



D

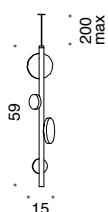

658/1SG
5 x LED 1W
615 lumen -
3000 K



D

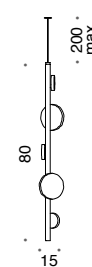

655/3P
15 x LED 1W
1845 lumen -
3000 K



B - C

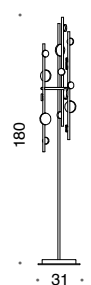

655/1A
4 x LED 1W
492 lumen -
3000 K



D

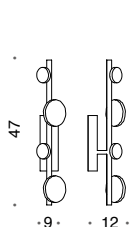

655/2A
8 x LED 1W
984 lumen -
3000 K



D

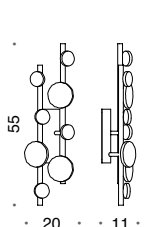

655/LP
3 x LED 1W
369 lumen -
3000 K



D

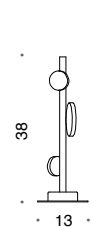

655/LG
4 x LED 1W
492 lumen -
3000 K



D

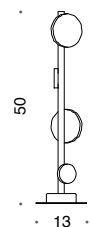



artic

DESIGN CRISTIAN FELTRIN







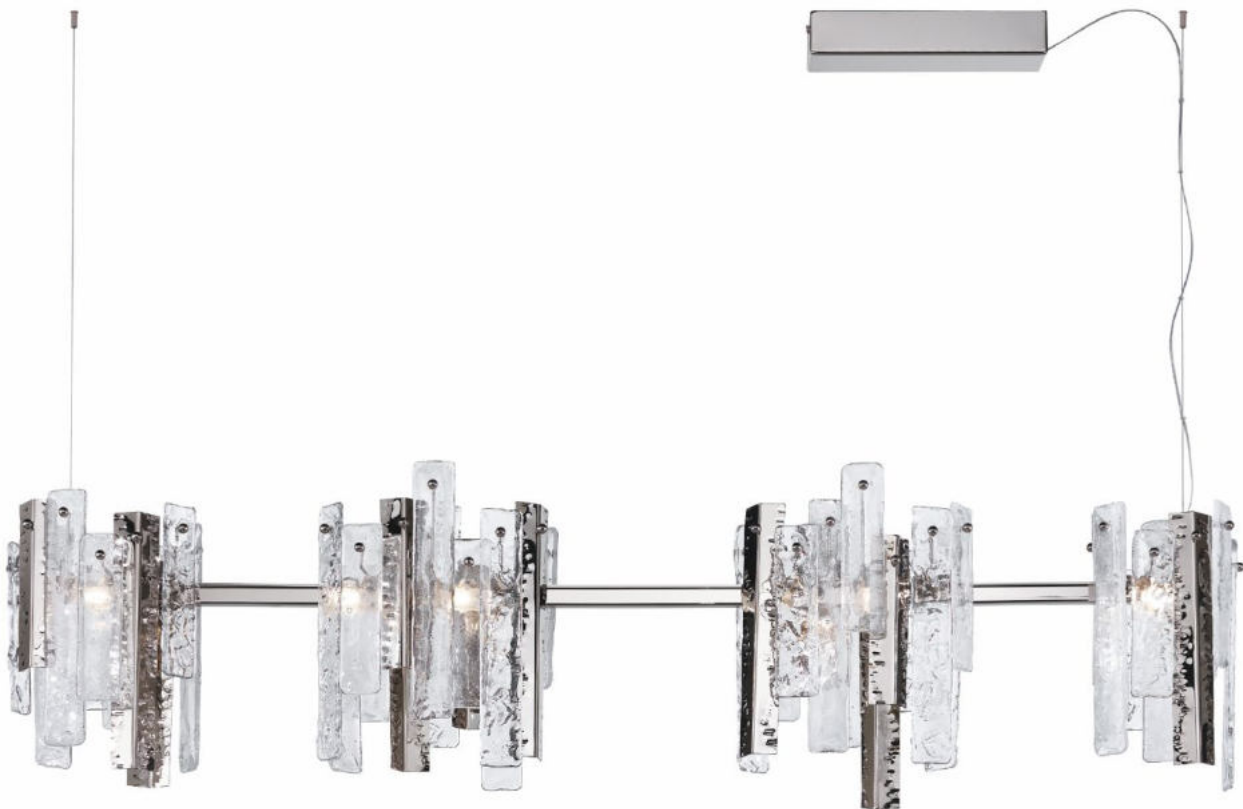





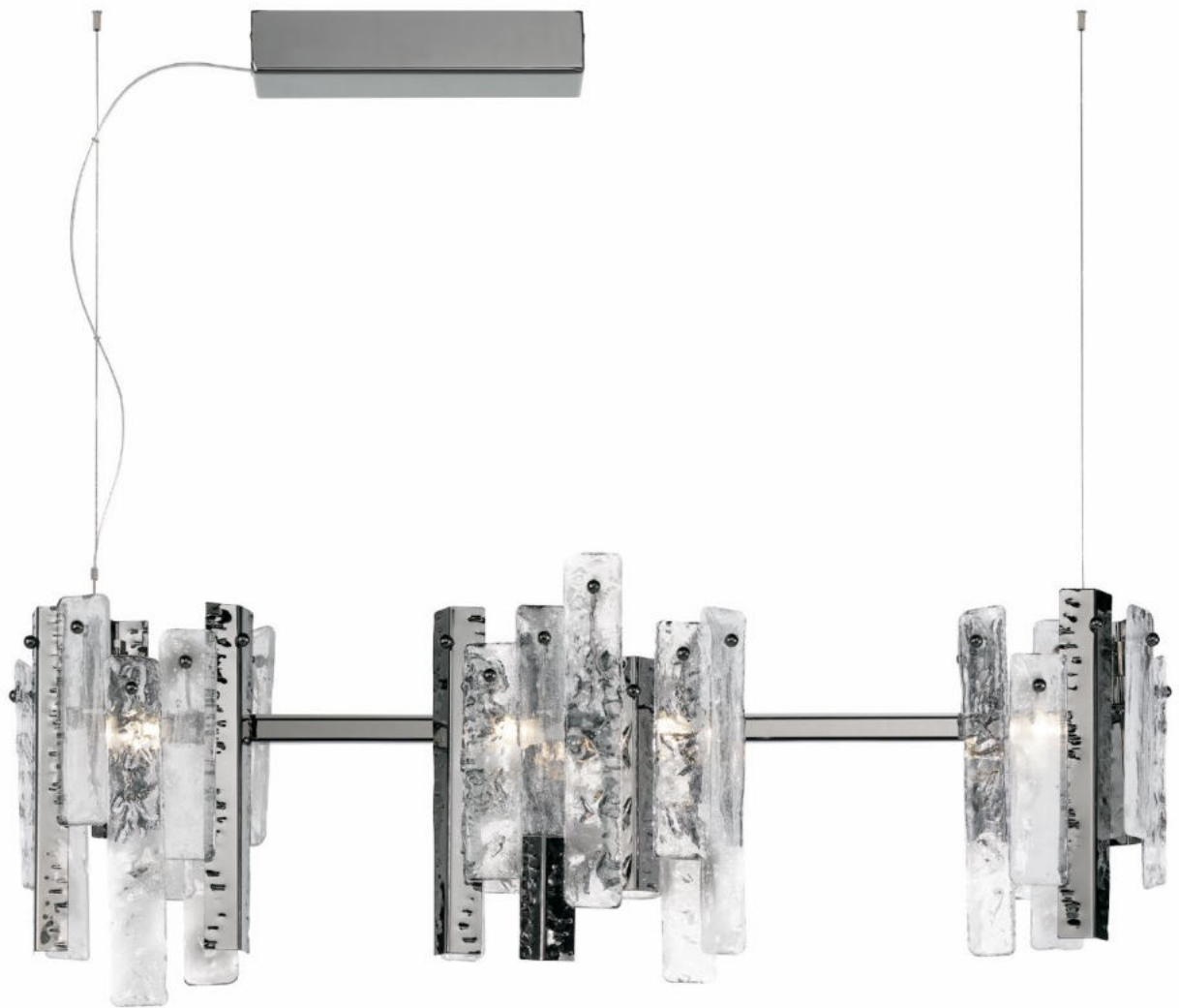



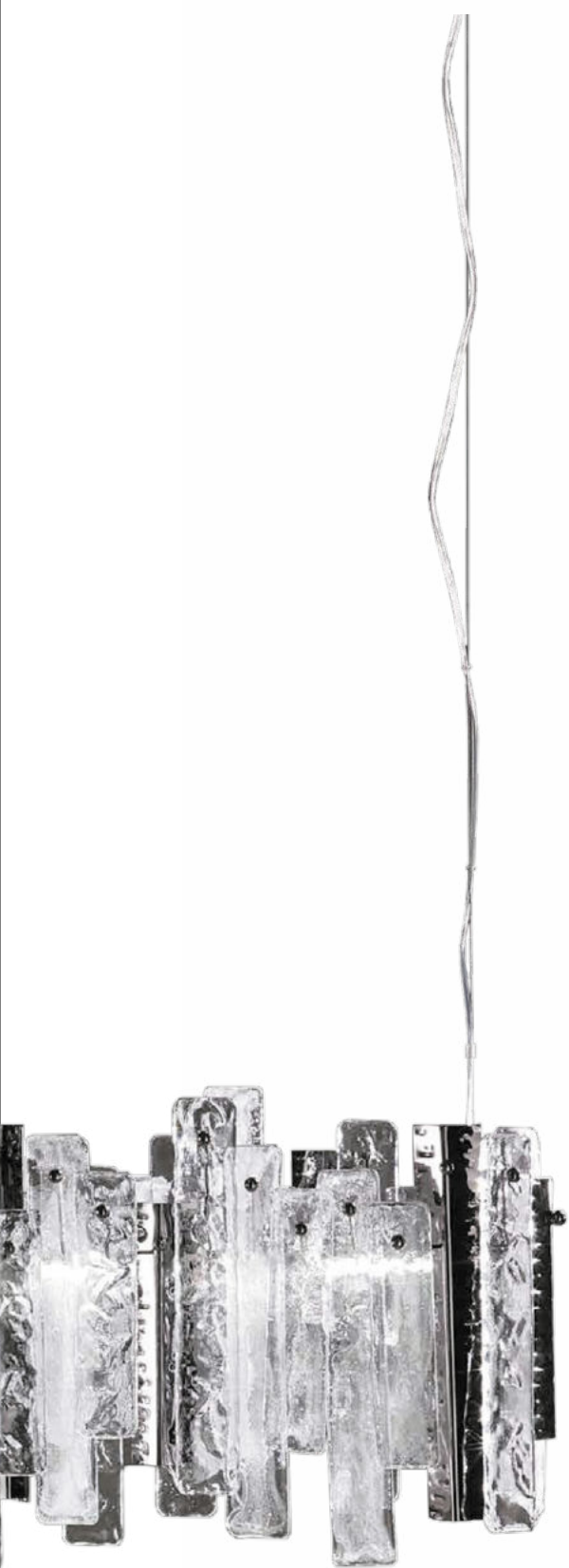

642/150
sospensione | suspension



643/4
sospensione | suspension









artic

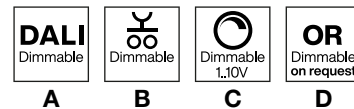

DESIGN **CRISTIAN FELTRIN**

Il telaio in metallo è disponibile nelle seguenti finiture:

- oro chiaro
- nichel nero
- pure steel

Vetro di Murano trasparente pulegoso e martellato abbinato con lame in metallo oro chiaro, nichel nero o pure steel.

Metal frame is available in the following finishes:

- light gold
- black nickel
- pure steel

Pulegoso or hammered transparent Murano glass with light gold, black nickel or pure steel metal blades.

642/60PF
2 STRIP LED
MAX 37W
5122 lumen - 3000 K



D

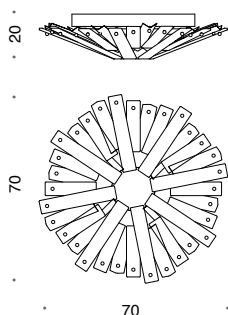

642/90PF
2 STRIP LED
MAX 55W
7486 lumen - 3000 K



D

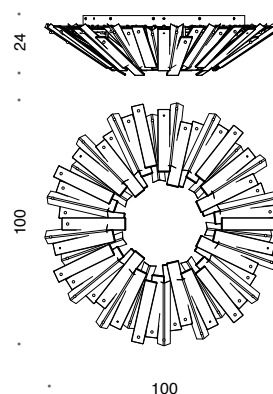

642/115
10 x LED 3,6W
3850 lumen - 3000 K



D

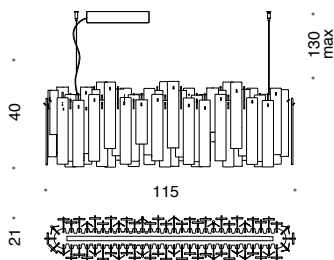

642/150
14 x LED 3,6W
5390 lumen - 3000 K



D

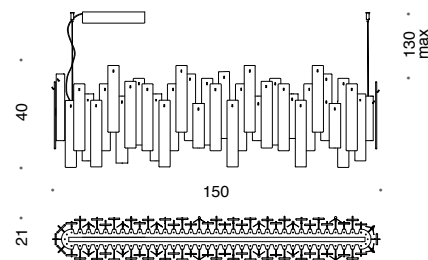

643/10
8 x LED 3,6W
3080 lumen - 3000 K



D

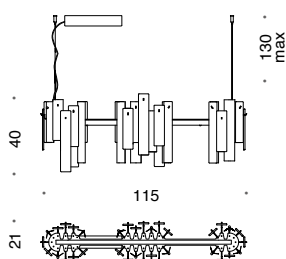

643/12
12 x LED 3,6W
4620 lumen - 3000 K



D

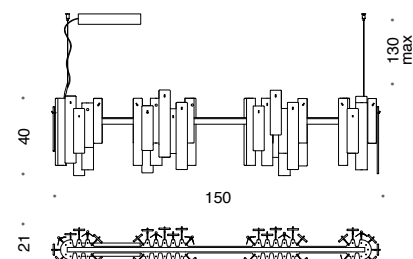

642/50
1 STRIP LED
MAX 15W
1970 lumen - 3000 K



D

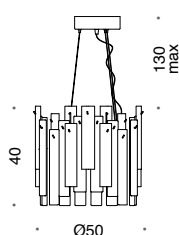

642/70
1 x STRIP LED
MAX 25W
3349 lumen - 3000 K



D

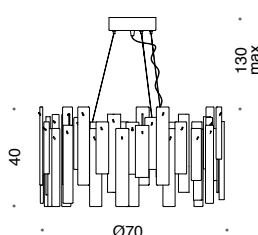

643/4
4 x LED 3,6W
1540 lumen - 3000 K



D

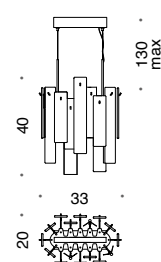

642/90
 1 STRIP LED
 MAX 35W
 4728 lumen - 3000 K
 CE ⊕ ▽

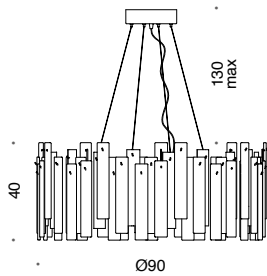

D

641/90
 4 STRIP LED
 MAX 75W
 10047 lumen - 3000 K
 CE ⊕ ▽

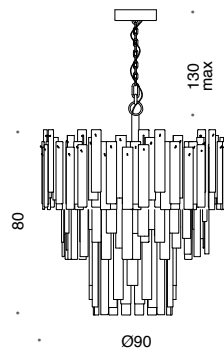

D

642/L
 1 STRIP LED
 MAX 6W
 788 lumen -
 3000 K
 CE ⊕ ▽

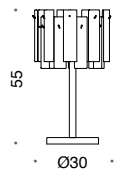

D

642/3ADX
 3 x LED 3,6W
 1155 lumen -
 3000 K
 CE ⊕ ▽

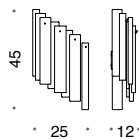

D

642/3ASX
 3 x LED 3,6W
 1155 lumen -
 3000 K
 CE ⊕ ▽

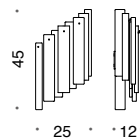

D



642/3ASX
 applique | wall bracket



ice rain

DESIGN **CRISTIAN FELTRIN**



< 507/12
507/18
sospensione | suspension









507/6A
applique | wall bracket



507/6A
applique | wall bracket



507/3A
applique | wall bracket













507/6P
lampada da terra | floor lamp

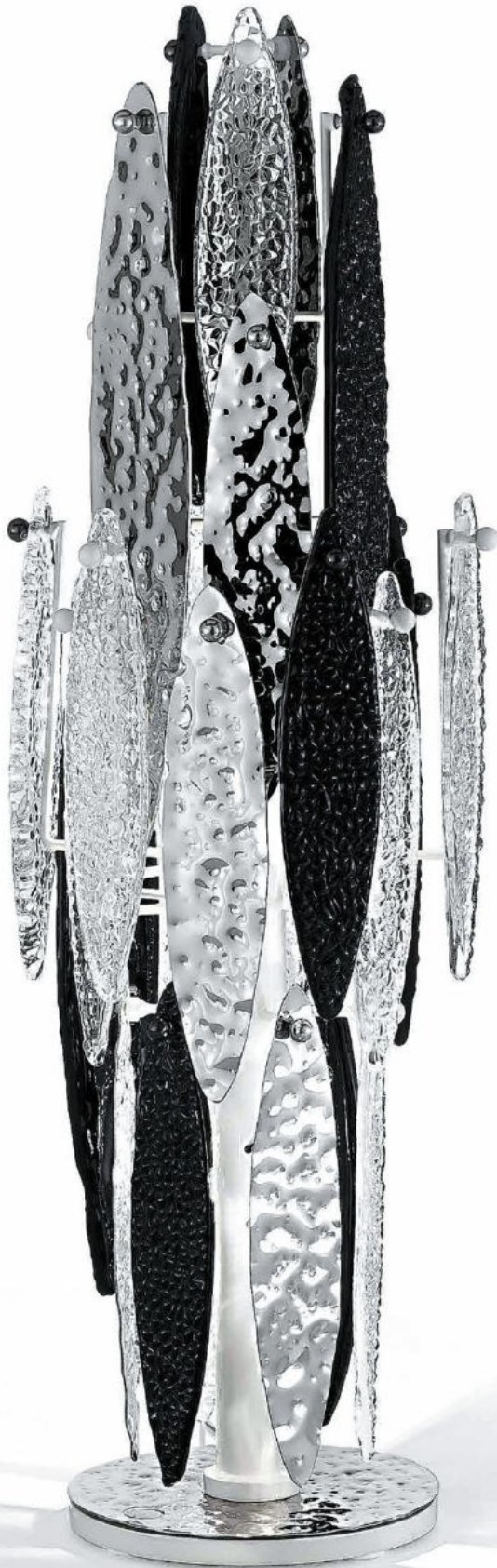

ice rain

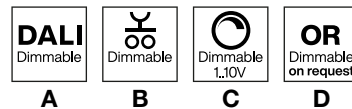

DESIGN **CRISTIAN FELTRIN**

La collezione è disponibile nei seguenti abbinamenti colore:

- **CRISTALLO:** telaio in metallo avorio lucido con foglie di vetro di Murano trasparenti.
- **BIANCO:** telaio in avorio lucido con foglie di vetro di Murano bianche.
- **MULTICOLORE:** telaio in avorio lucido con:
 - A. foglie in vetro di Murano bianco e trasparenti con foglie in metallo oro chiaro effetto martellato.
 - B. foglie in vetro Murano trasparenti con foglie in metallo oro chiaro effetto martellato.
 - C. foglie in vetro di Murano nere e trasparenti con foglie di metallo pure steel effetto martellato.

The collection is available in the following colour combinations:

- **CRYSTAL:** metal frame in soft ivory with leaves of transparent Murano glass.
- **WHITE:** metal frame in soft ivory with leaves of white Murano glass.
- **MULTICOLOR:** metal frame in soft ivory with:
 - A. leaves in crystal and white Murano glass with light gold metal leaves with hammered effect.
 - B. leaves in crystal Murano glass with light gold metal leaves with hammered effect.
 - C. leaves in crystal and black Murano glass with pure steel metal leaves with hammered effect.

508/12
12 LED - MAX 2,3W
3564 lumen
2800 K
CE ⊕ ▽

D

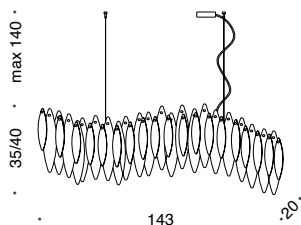

508/10
10 LED - MAX 2,3W
2970 lumen
2800 K
CE ⊕ ▽

D

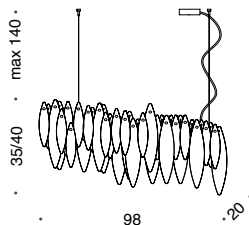

508/120
2xSTRIP LED 14.4W
MAX 92W
12350 lumen 3000K
CE ⊕ ▽

D

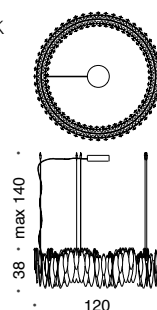

508/80
2xSTRIP LED 14.4W
MAX 58W
7600 lumen 3000K
CE ⊕ ▽

D

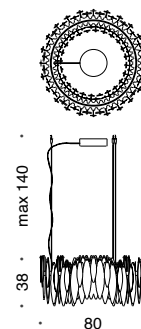

507/18
18 LED - MAX 2,3W
5346 lumen
2800 K
CE ⊕ ▽

D

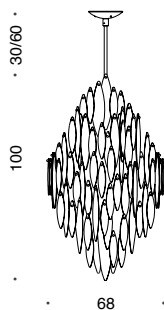

507/12
12 LED - MAX 2,3W
3564 lumen
2800 K
CE ⊕ ▽

D

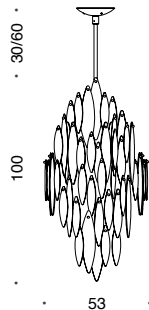

507/10
10 LED - MAX 2,3W
2970 lumen
2800 K
CE ⊕ ▽

D

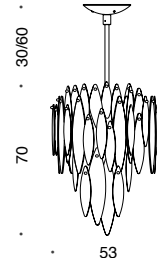

507/6S
6 LED - MAX 2,3W
1782 lumen
2800 K
CE ⊕ ▽

D

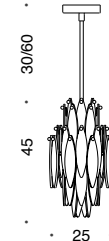

507/12PF
12 LED - MAX 2,3W
3270 lumen
2800 K
CE ⊕ ▽

D

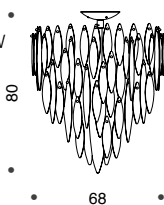

507/10PF
10 LED - MAX 2,3W
2700 lumen
2800 K
CE ⊕ ▽

D

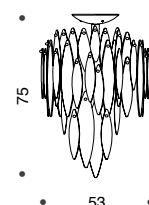

507/6A
6 LED - MAX 2,3W
1620 lumen
2800 K
CE ⊕ ▽

D

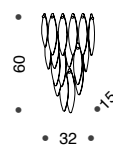

507/3A
3 LED - MAX 2,3W
810 lumen
2800 K
CE ⊕ ▽

D

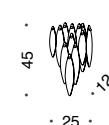

507/6P
6 LED - MAX 2,3W
1620 lumen
2800 K
CE ⊕ ▽

D

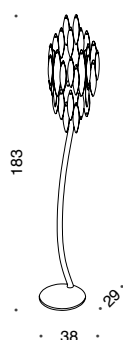

507/4L
4 LED - MAX 2,3W
1080 lumen
2800 K
CE ⊕ ▽

D

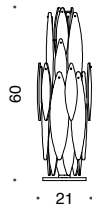



elite

DESIGN CRISTIAN FELTRIN







596/8+1PF
plafoniera | ceiling lamp









596/2+1A
applique | wall bracket



elite

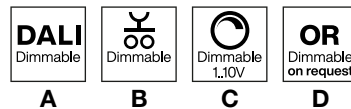

DESIGN **CRISTIAN FELTRIN**

Telaio in metallo disponibile nelle seguenti finiture:

- pure steel
- oro chiaro
- bronzo

Le foglie in vetro di Murano sono disponibili nei colori:

- bianco
- trasparente
- nero

Disponibile realizzazioni su misura.

Metal frame available in the following finishes:

- pure steel
- light gold
- bronzo

The leaves, in Murano glass, are available in the colors:

- white
- crystal
- black

Custom-made sizes available.

596/28+3

28 x G9
 MAX 33W
 + 3 LED x 2W
 480 lumen
 2800 K



D

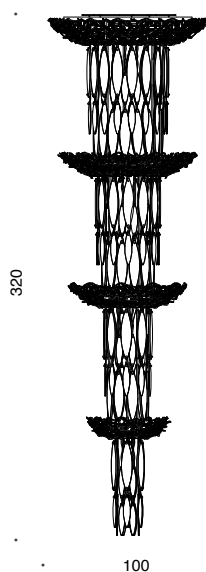

596/34+3

34 x G9
 MAX 33W
 + 3 LED x 2W
 480 lumen
 2800 K



D

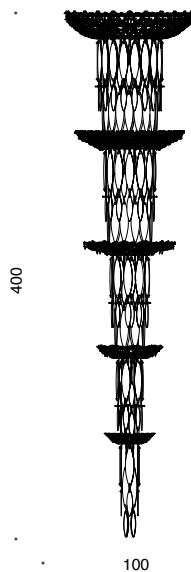

596/41+6

41 x G9
 MAX 33W
 + 6 LED x 2W
 960 lumen
 2800 K



D

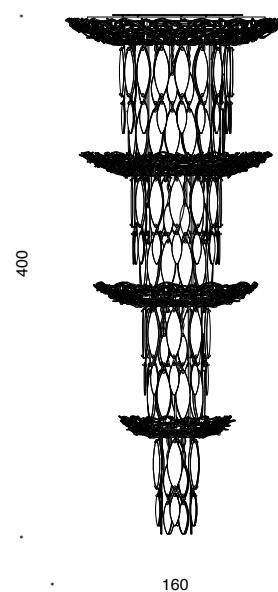

596/8+1

8 x G9
 MAX 33W
 + 1 LED x 2W
 160 lumen
 2800 K



D

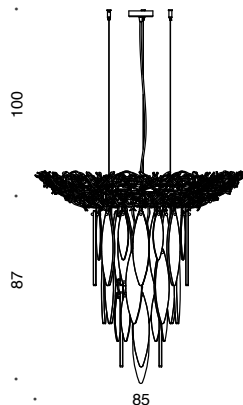

596/150

14 x G9
 MAX 33W
 + 5 LED x 2W
 970 lumen
 2800 K



D

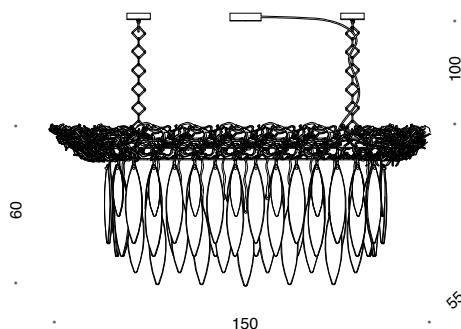

596/4+1

4 x G9
 MAX 33W
 + 1 LED x 2W
 160 lumen
 2800 K



D

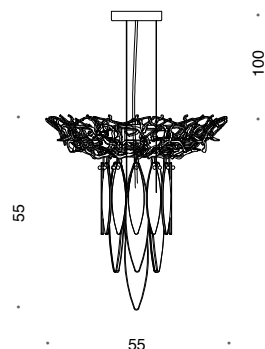

596/8+1PF

8 x G9
 MAX 33W
 + 1 LED x 2W
 160 lumen
 2800 K



D

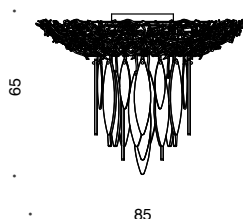

596/2+1A

2 x G9
 MAX 33W
 + 1 LED x 2W
 160 lumen
 2800 K



D

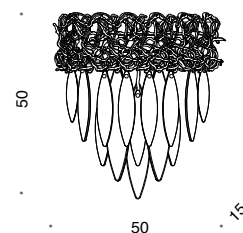



groovy

DESIGN CRISTIAN FELTRIN



< 464/12
sospensione | suspension

463/1P
lampada da terra | floor lamp





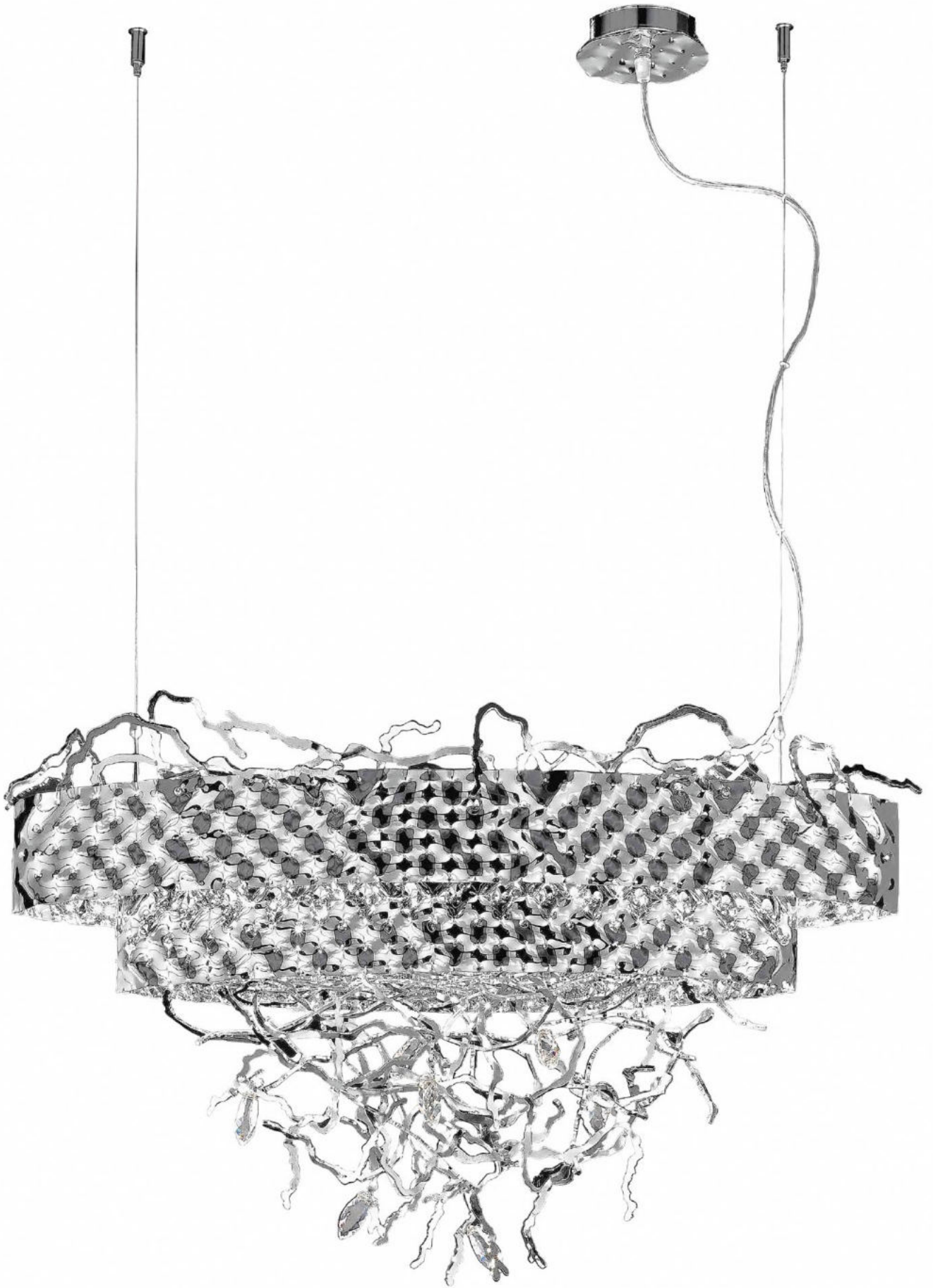

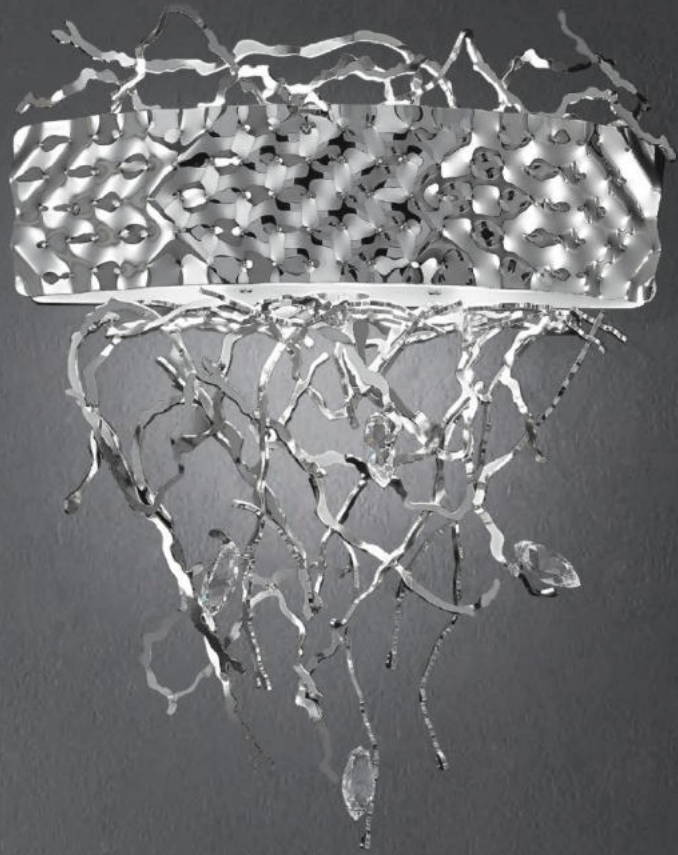

463/1A
applique | wall bracket















groovy

DESIGN CRISTIAN FELTRIN

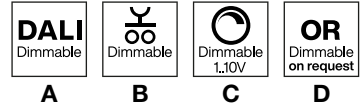

La collezione è disponibile nei seguenti abbinamenti colore:

- fascia bianco velluto e rami pure steel o oro chiaro
- fascia nero velluto e rami pure steel o oro chiaro
- fascia foglia nera e rami pure steel o oro chiaro
- tutto pure steel
- tutto oro chiaro

Nell'appliche i diffusori sono in vetro plexiglass satinato.

La collezione è decorata con cristalli trasparenti

Disponibile realizzazioni su misura.

The collection is available in the following colour combinations:

- velvet white band and pure steel or light gold branches
- velvet black band and pure steel or light gold branches
- black leaf band and pure steel or light gold branches
- entirely pure steel
- entirely light gold

The diffusers for the wall brackets are in satin Plexiglass.

The collection is decorated with transparent crystals.

Custom-made sizes available.

463/12
12 x G9
MAX 33W



D

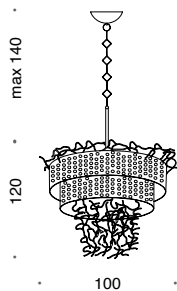

463/10
10 x G9
MAX 33W



D

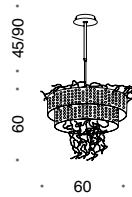

463/6
6 x G9
MAX 33W



D

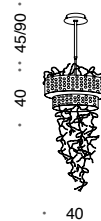

464/12
12 x G9
MAX 33W



D

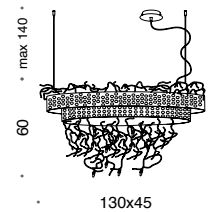

464/6
6 x G9
MAX 33W



D

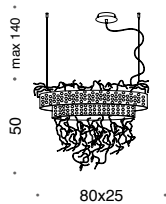

463/8PF
8 x G9
MAX 33W



D

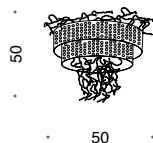

463/10PF
10 x G9
MAX 33W



D

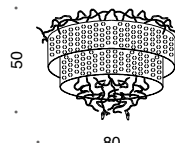

463/1P
1 x E27
MAX 77W



D

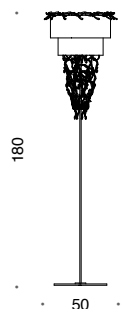

463/1A
2xLED
5W 1150 lumen



D

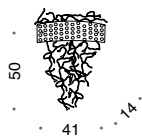

463/2AP
2 x G9
MAX 33W



D

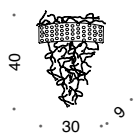

463/1L
1 x E14
MAX 60W



D

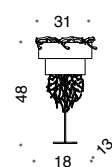



weave

DESIGN **CRISTIAN FELTRIN**





< 513/12
sospensione | suspension

513/8
sospensione | suspension







514/6
sospensione | suspension

170 weave







1

2

- 1 **511/3**
 - 2 **511/4**
- sospensione | suspension









511/4L
lampada da tavolo | table lamp





1



2

1 **591/1L**
2 **590/1L**
lampada da tavolo | table lamp

weave

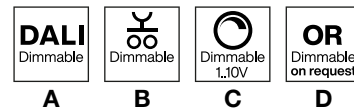

DESIGN **CRISTIAN FELTRIN**

Telaio in metallo disponibile nelle finiture:

- pure steel con catene nichel
- oro chiaro con catene dorate
- bronzo con catene bronzo

Per le lampade da tavolo i paralumi in tessuto sono in:

- iuta chiaro o scuro
- chinette avorio o tortora

Per le lampade con paralumi in metallo le finiture sono stesse del telaio.

Disponibile realizzazioni su misura.

The metal frame is available in the finishes:

- pure steel with nickel chains
- light gold with golden chains
- bronze with bronze chains

For the table lamps the lampshades in fabric are in:

- light or dark jute
- ivory or dove grey chinette

For the table lamps with metal lampshades the finishes are the same of the frame.

Custom-made sizes available.

513/16
16 x G9
MAX 33W



D

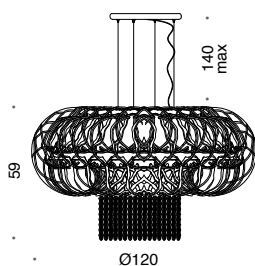

513/12
12 x G9
MAX 33W



D

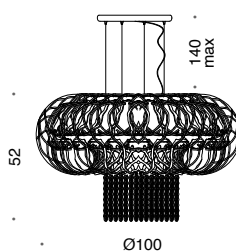

513/8
8 x G9
MAX 33W



D

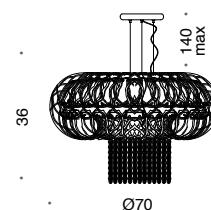

513/6
6 x G9
MAX 33W



D

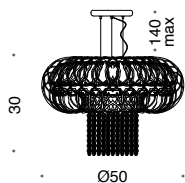

511/6
6 x G9
MAX 33W



D

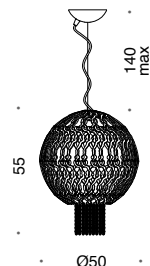

511/4
4 x G9
MAX 33W



D

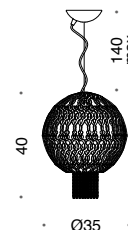

511/3
3 x G9
MAX 33W



D

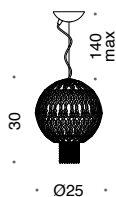

514/6
6 x G9
MAX 33W



D

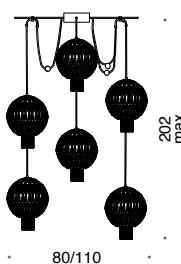

513/26
26 x G9
MAX 33W



D



513/8PF
8 x G9 
MAX 33W
CE   

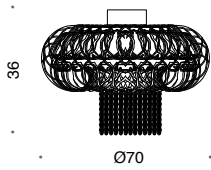

D

513/6PF
6 x G9 
MAX 33W
CE   

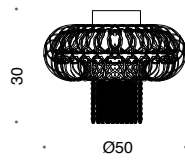

D

513/3A
3 x G9 
MAX 33W
CE   

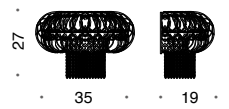

D

511/2A
2 x G9 
MAX 33W
CE   

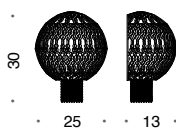

D

511/1L
1 x E27 
MAX 77W
CE   

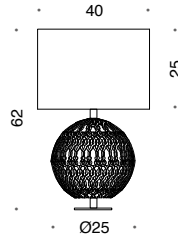

D

511/4L
4 x G9 
MAX 33W
CE   

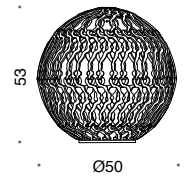

D

511/3L
3 x G9 
MAX 33W
CE   

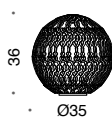

D

511/2L
2 x G9 
MAX 33W
CE   

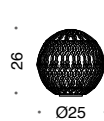

D

590/1L
1 x E27 
MAX 77W
CE   

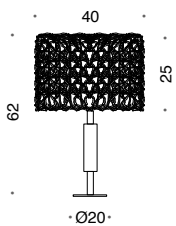

D

591/1L
1 x E27 
MAX 77W
CE   

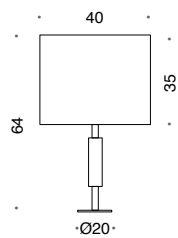

D



tribù

DESIGN CRISTIAN FELTRIN







661/2L
lampada da tavolo | table lamp



1



2





1

- 1 **661/2A**
- 2 **661/1A**
applique | wall bracket



1



2



2

- 1 **660/2A**
- 2 **660/1A**
applique | wall bracket



tribù



A



B



C



D

DESIGN **CRISTIAN FELTRIN**

Il telaio in metallo è disponibile nelle seguenti finiture:

- oro antico lucido
- oro chiaro
- pure steel
- bianco velluto

Vetro di Murano trasparente martellato.

Metal frame is available in the following finishes:

- glossy antique gold
- light gold
- pure steel
- velvet white

Hammered transparent Murano glass

660/10
10 x LED 3,6W
3850 lumen - 3000 K
CE ⊕ ▽

D

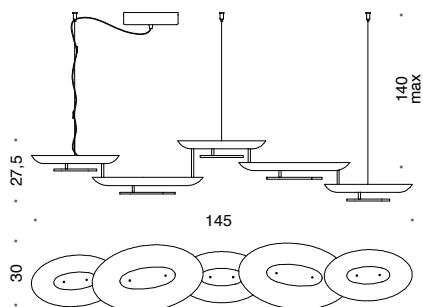

661/2L
2 x LED 3,6W
770 lumen -
CE ⊕ ▽

B

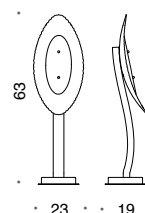

660/1A
1 x LED 3,6W
385 lumen -
CE ⊕ ▽

D

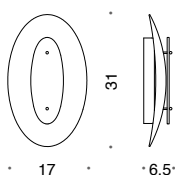

660/2A
2 x LED 3,6W
770 lumen -
CE ⊕ ▽

D

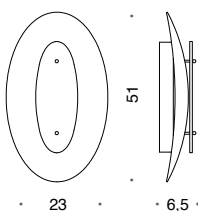

661/1A
1 x LED 3,6W
385 lumen -
CE ⊕ ▽

D

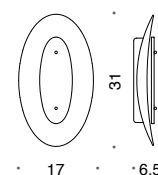

661/2A
2 x LED 3,6W
770 lumen -
CE ⊕ ▽

D

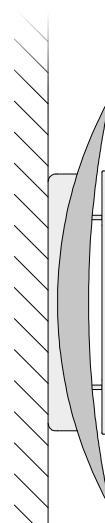
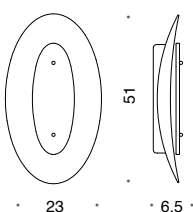

661

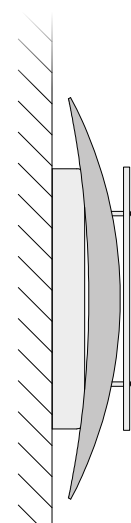

660



chrysalis

DESIGN **CRISTIAN FELTRIN**



1



2

- 1 **448/5+3**
 - 2 **448/6+3**
- sospensione | suspension









448/84PF
plafoniera | ceiling lamp



448/3PF
plafoniera | ceiling lamp



448/5+3PF
plafoniera | ceiling lamp









448/3ASX
applique | wall bracket



448/3ADX
applique | wall bracket



448/5L
lampada da tavolo | table lamp



448/3L
lampada da tavolo | table lamp





448/6+5P
lampada da terra | floor lamp

chrysalis

DESIGN **CRISTIAN FELTRIN**

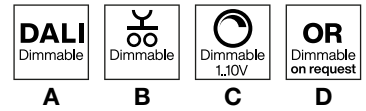

Telaio in metallo, disponibile nelle seguenti finiture:

- oro chiaro
- pure steel
- black aubergine
- nichel nero

Catene pendenti in rame con finitura nichel satinato o dorate.

Negli articoli 448/6+3 (448/6), 448//6+5P (448/6P) gli articoli sono forniti di serie senza catene pendenti.

La collezione è decorata con cristalli trasparenti.

Disponibile realizzazioni su misura.

Metal frame, available in the following finishes:

- light gold
- pure steel
- black aubergine
- black nickel

Copper pendant chains in satin nickel or golden finish.

Articles 448/6+3 (448/6), 448/6+5P (448/6P) are supplied standard without pendant chains.

The collection is decorated with transparent crystals.

Custom-made sizes available.

448/2000LED
2 x striscia LED 46W
3456 lumen
3200 K



D

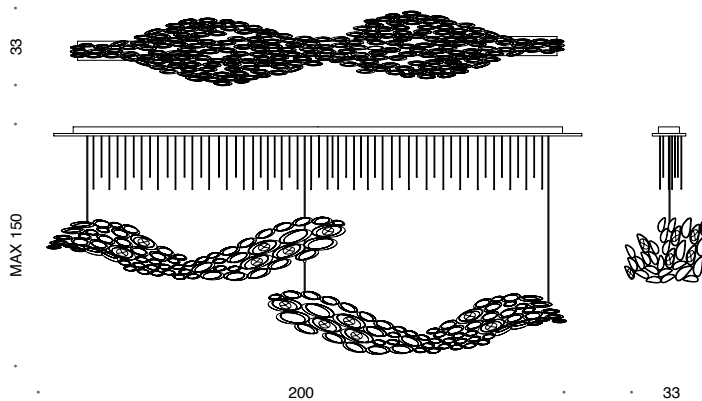

448/27
27 x G9 LED
MAX 33W



D

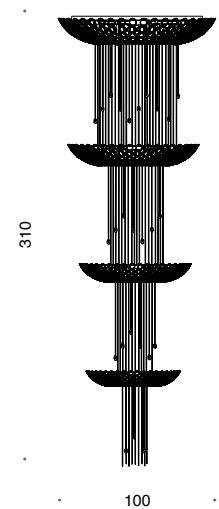

448/8SLED
8 LED x 2W
1552 lumen
2700 K



D

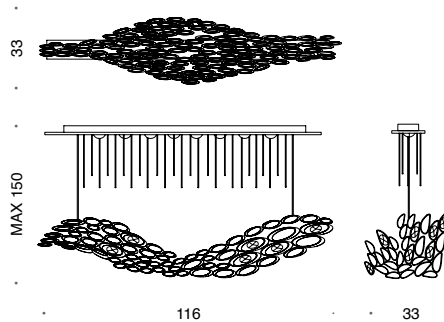

448/8+3
doppia accensione
double switch
8 x G9 LED
MAX 33W
+ 3 LED x 1W
369 lumen
2700 K



448/8
8 x G9 LED
MAX 33W



D



448/6+3
doppia accensione
double switch
6 x G9 LED
MAX 33W
+ 3 LED x 1W
369 lumen
2700 K



448/6
6 x G9 LED
MAX 33W



D



448/5+3
doppia accensione
double switch
5 x G9 LED
MAX 33W
+ 3 LED x 1W
369 lumen
2700 K



448/5
5 x G9 LED
MAX 33W



D

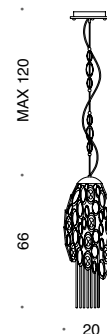

448/3+3
doppia accensione
double switch
3 x G9 LED
MAX 33W
+ 3 LED x 1W
369 lumen
2700 K



448/3
3 x G9 LED
MAX 33W



D

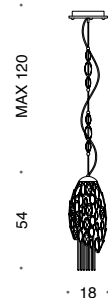

448/8+3PF

doppia accensione
double switch
8 x G9 
MAX 33W
+ 3 LED x 1W
369 lumen
2700 K

  

448/8PF

8 x G9 
MAX 33W

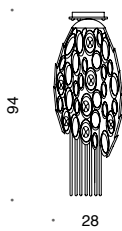

D**448/5+3PF**

doppia accensione
double switch
5 x G9 
MAX 33W
+ 3 LED x 1W
369 lumen
2700 K

  

448/5PF

5 x G9 
MAX 33W

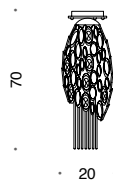

D**448/3+3PF**

doppia accensione
double switch
3 x G9 
MAX 33W
+ 3 LED x 1W
369 lumen
2700 K

  

448/3PF

3 x G9 
MAX 33W

D**448/84PF**

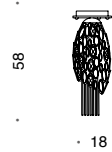
8 x G9 
MAX 33W

D**448/spot**

1 x GU10 LED
4,6W
2700K

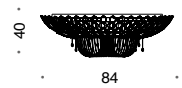
D

 foro ø 8,5cm

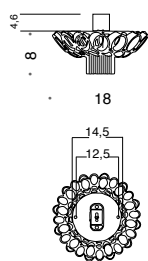
448/3ADX

3 x G9 
MAX 33W

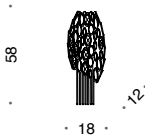

D**448/3ASX**

3 x G9 
MAX 33W

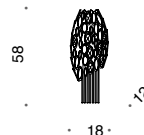

D**448/6+5P**

doppia accensione
double switch
6 x G9 
MAX 33W
+ 5 LED x 1W
615 lumen
2700 K

  

448/6P

6 x G9 
MAX 33W

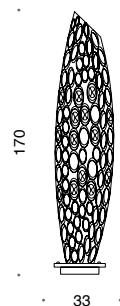

D**448/1LG**

1 x E27 
MAX 77W

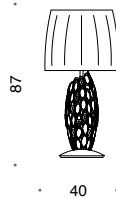

D**448/5L**

5 x G9 
MAX 33W

D**448/3L**

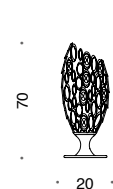
3 x G9 
MAX 33W

D

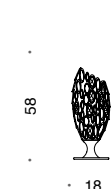

leaves

DESIGN CRISTIAN FELTRIN

















leaves

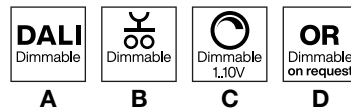

DESIGN **CRISTIAN FELTRIN**

Telaio in metallo, disponibile nelle seguenti finiture:

- oro chiaro
- pure steel
- nichel nero
- bronzo scuro

Decorato con vetro di Murano trasparente.

Metal frame, available in the following finishes:

- light gold
- pure steel
- black nickel
- dark bronze

Decorated with transparent Murano glass

605/10
5 x G9
MAX 33W and
5 LED x 1W
600 lumen 2800K



D

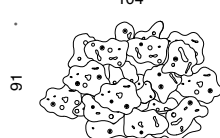
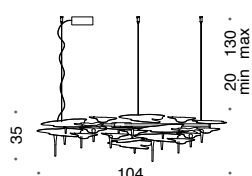

606/10



Single fastening

605/16
8 x G9
MAX 33W and
8 LED x 1W
960 lumen 2800K



D

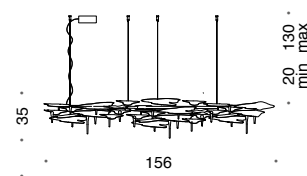

606/16



Single fastening

605/8
8 LED x 2,3W
1200 lumen 2800K



D

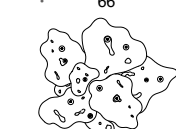
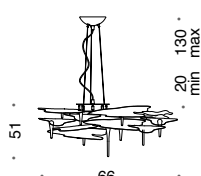

605/1S
1 LED x 2,3W
150 lumen 2800K



D

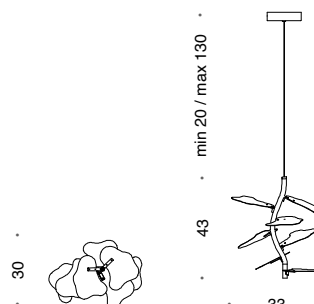

605/10PF
5 x G9
MAX 33W and
5 LED x 1W
600 lumen
2800K



D

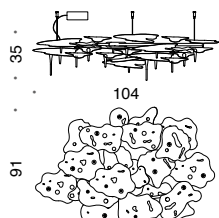

605/16PF
8 x G9
MAX 33W and
8 LED x 1W
960 lumen
2800K



D

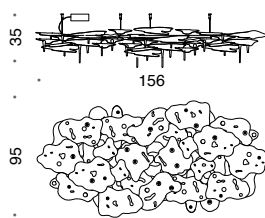

605/5PF
5 x G9
MAX 33W



D

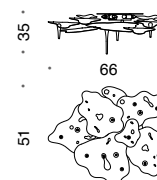

605/5A
5 x G9
MAX 33W



D

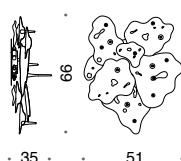



cesare

DESIGN CRISTIAN FELTRIN



- 1 **632/110**
 - 2 **632/76**
 - 3 **632/50**
- sospensione | suspension







cesare

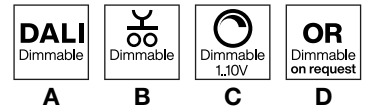

DESIGN **CRISTIAN FELTRIN**

Telaio in metallo disponibile nelle finiture:

- nichel spazzolato
- nichel nero spazzolato
- oro spazzolato
- bronzo spazzolato

Vetro di Murano con incisione disponibile nelle finiture:

- cristallo
- fumè
- bronzo

Metal frame available in the finishes:

- brushed nickel
- brushed black nickel
- brushed gold
- brushed bronze

Murano glass with engraving available in the finishes:

- crystal
- fumè
- bronze

632/50
Strip led 36W
2400 lumen 3000K
CE ⊕ ▽

D

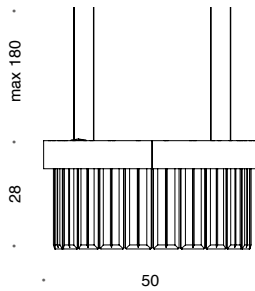

632/76
Strip led 55W
3800 lumen 3000K
CE ⊕ ▽

D

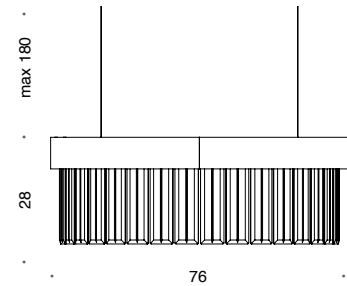

632/110
Strip led 79W
5500 lumen 3000K
CE ⊕ ▽

D

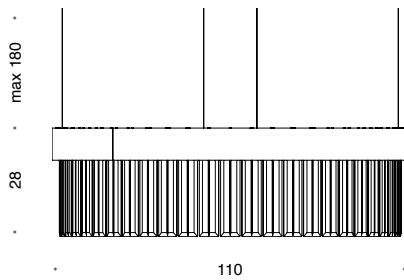

vetro senza incisione
glass without engraving



vetro con incisione
glass with engraving



roma

DESIGN ANTONIO PIVA















359/4A
applique | wall bracket



359/2A
applique | wall bracket





roma

DESIGN **ANTONIO PIVA**

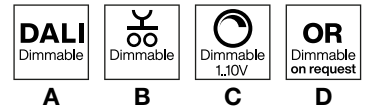

Telaio in metallo disponibile nelle seguenti finiture:
oro chiaro, nichel nero, cromo, black aubergine
I vetri diffusori, con o senza incisione centrale,
sono disponibili nei seguenti colori:
bronzo, trasparente, fumé, satinato bianco.
Disponibile realizzazioni su misura.

Metal frame available in the following finishes:
light gold, black nickel, chrome, black aubergine
Diffuser glasses, with or without engraving,
are available in the following colours:
bronzes, transparent, smoke grey, satin white.
Custom-made sizes available.

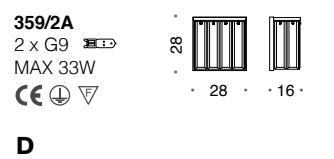
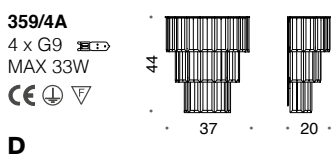
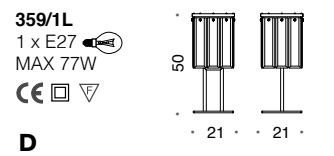
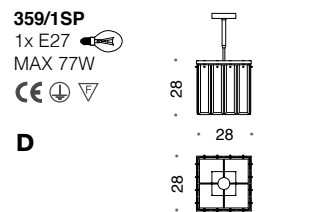
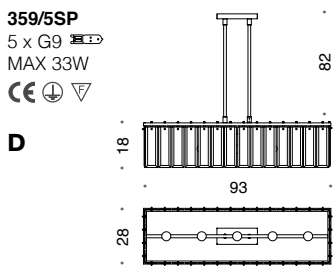
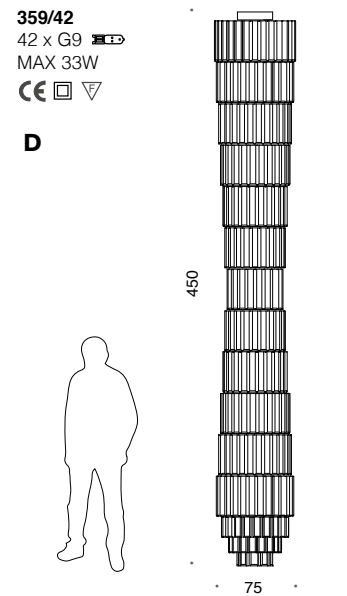
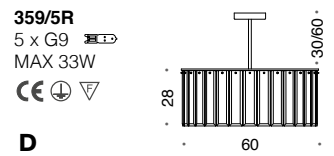
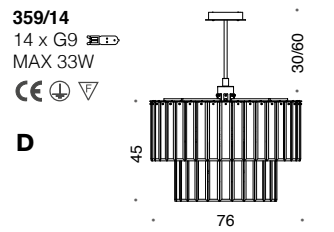
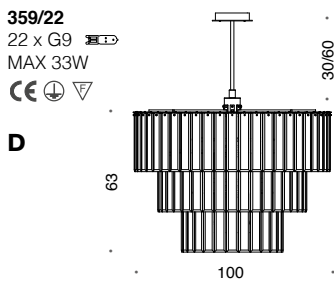

vetro senza incisione
glass without engraving



vetro con incisione
glass with engraving

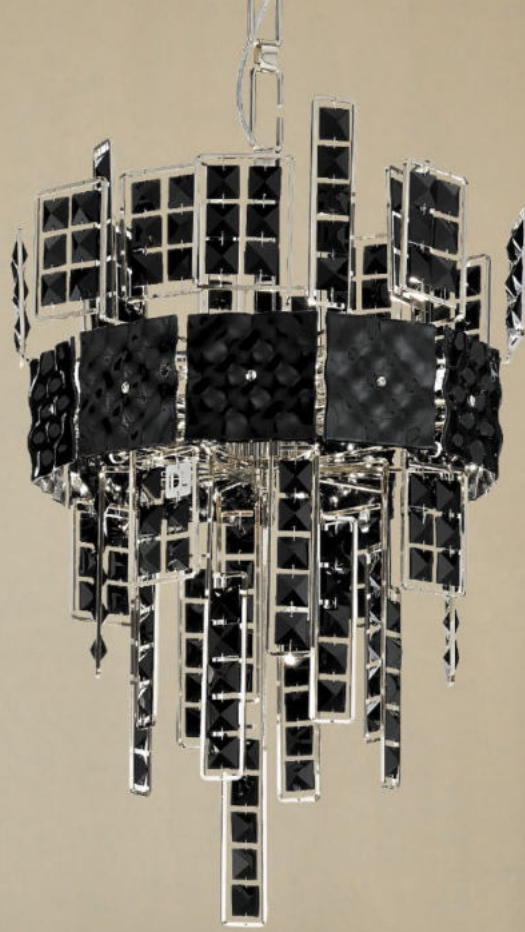

crystalline

DESIGN CRISTIAN FELTRIN



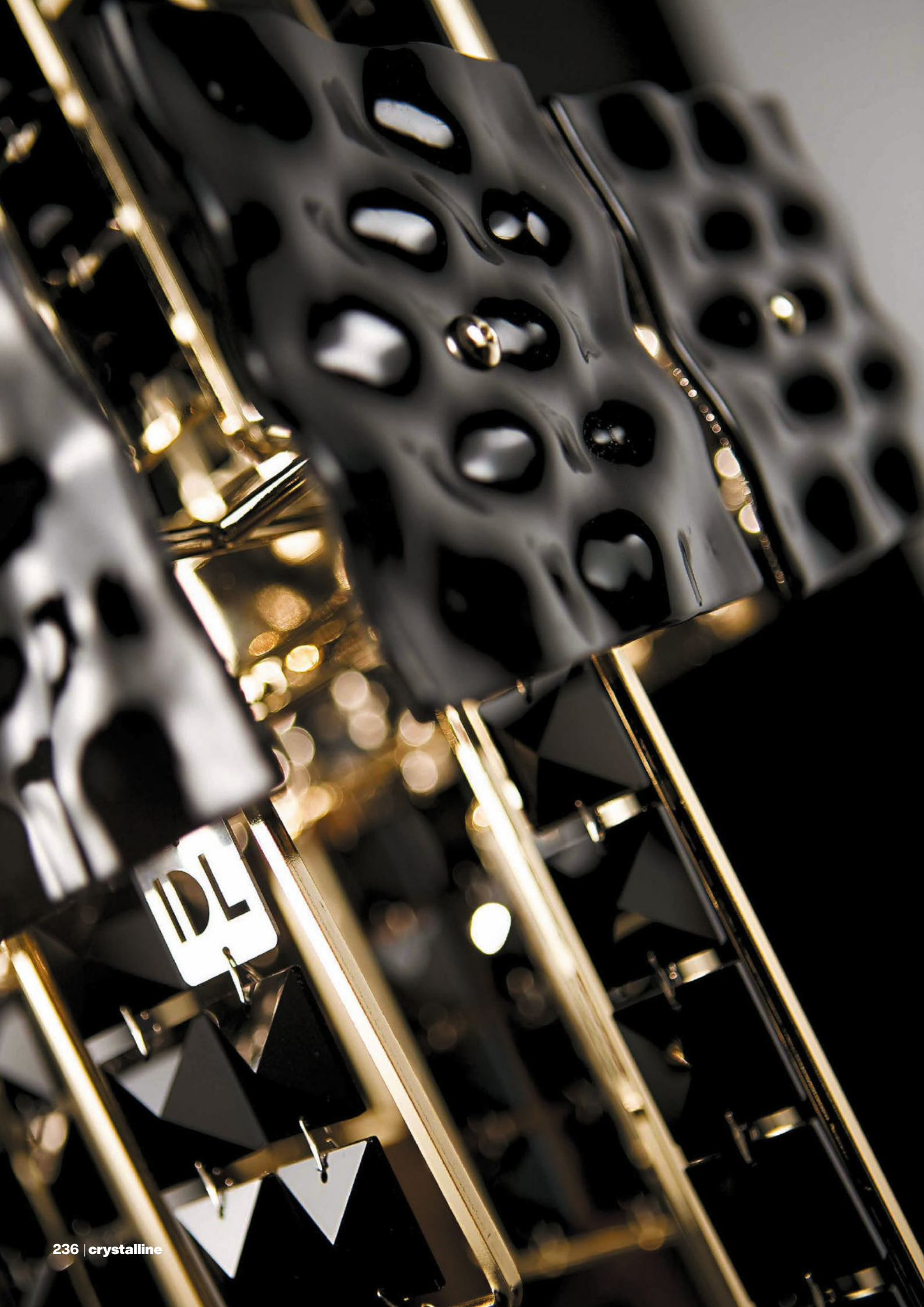

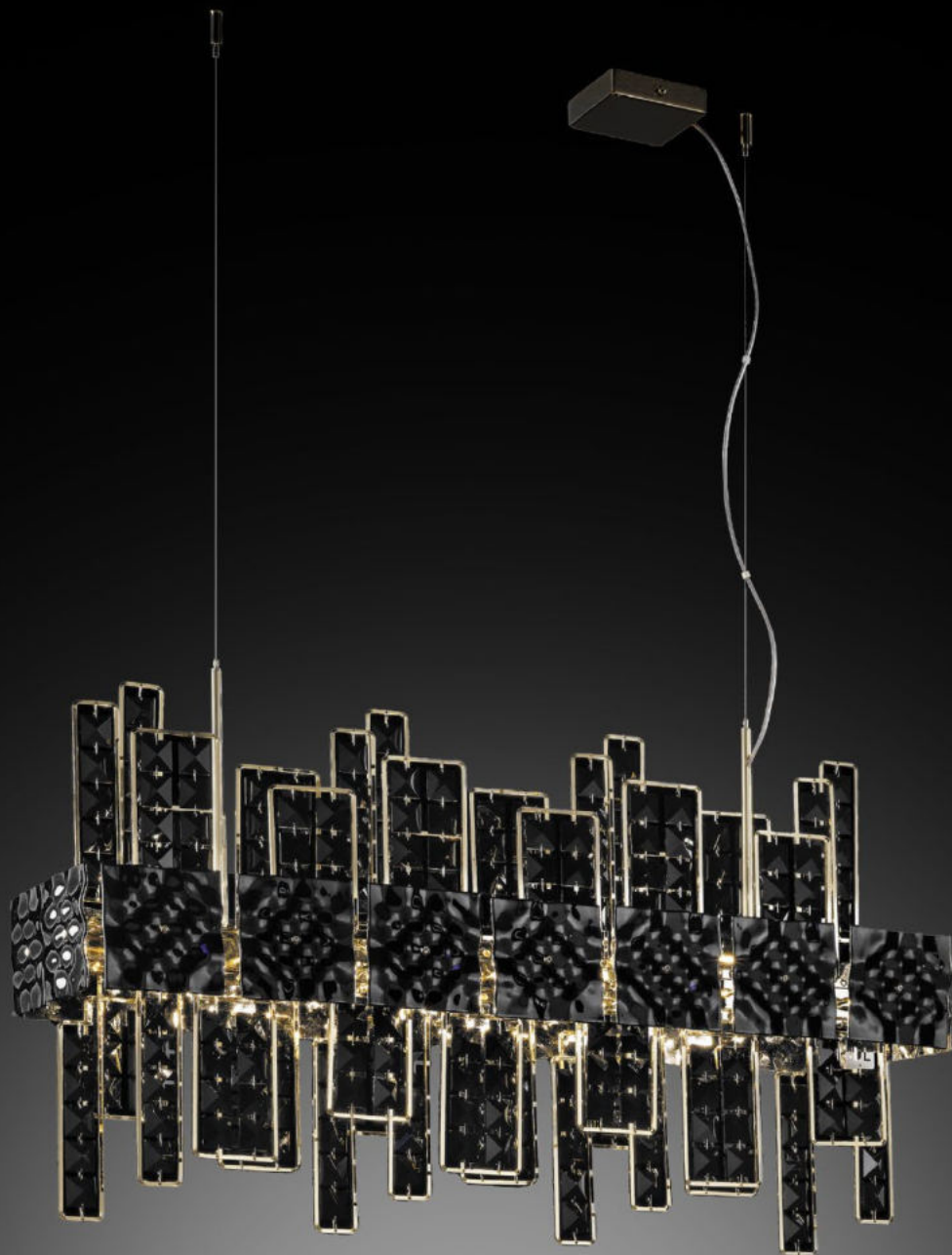









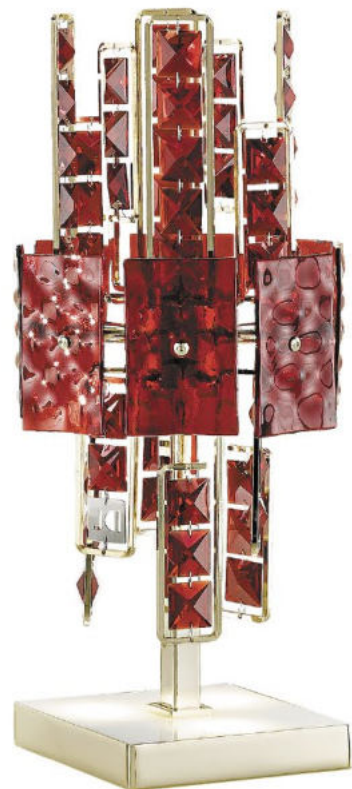

493/2A
applique | wall bracket

493/3L
lampada da tavolo | table lamp

493/6P
lampada da terra | floor lamp

crystalline

DESIGN **CRISTIAN FELTRIN**

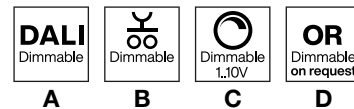

Telaio in metallo cromato o oro chiaro

Elementi in cristallo molato disponibili nelle seguenti varianti colore:

- cristallo trasparente
- cristallo bianco
- cristallo rosso
- cristallo nero

Nella lampada da tavolo e applique il diffusore è in policarbonato satinato.

Chromed or light gold metal frame.

Cut crystal elements available in the following colours:

- transparent crystal
- white crystal
- red crystal
- black crystal

On table lamp and wall bracket diffuser in satin polycarbonate.

493/16+16

32 x G9
 MAX 33W



D

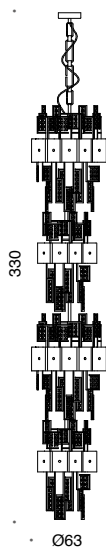

493/16

16 x G9
 MAX 33W



D

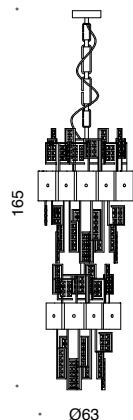

493/10

10 x G9
 MAX 33W



D

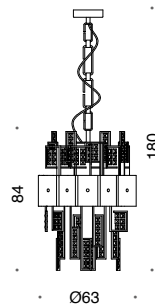

493/6

6 x G9
 MAX 33W



D

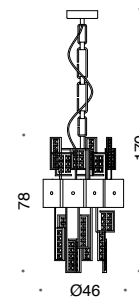

494/24

24 x G9
 MAX 33W



D

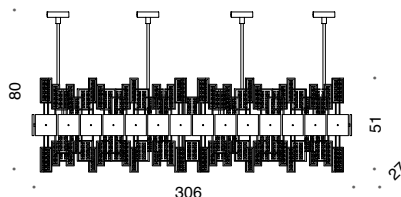

494/12

12 x G9
 MAX 33W



D

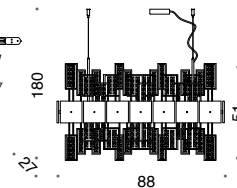

493/6P

6 x G9
 MAX 33W



D

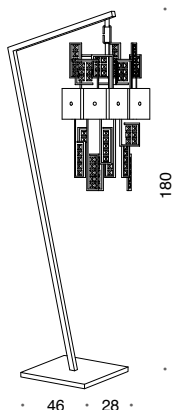

493/80PF

14 x G9
 MAX 33W



D

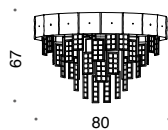

493/10PF

10 x G9
 MAX 33W



D

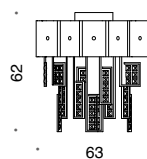

493/2A

2 x LED 2,3W
 540 lumen
 3000K



D

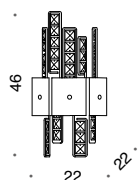

493/3L

3 x LED 2,3W
 810 lumen
 3000K



D

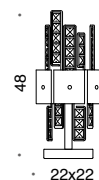



diamante

DESIGN **CRISTIAN FELTRIN**



< 628/50
sospensione | suspension

628/90
sospensione | suspension







diamante

DESIGN **CRISTIAN FELTRIN**

Telaio in metallo disponibile nelle finiture:

- cromo
- oro chiaro

Cristalli Asfour trasparenti



A



B



C



D

Metal frame available in the finishes:

- chrome
- light gold

Transparent Asfour crystals.

628/50
1 x STRIP LED
MAX 20W
2660 lumen 3000K
CE ⊕ ▽

D

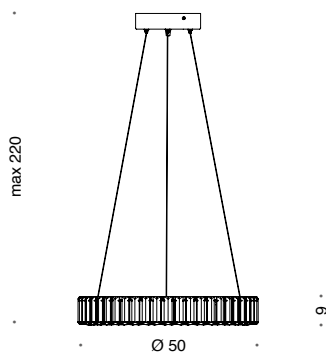

628/70
1 x STRIP LED
MAX 29W
3857 lumen 3000K
CE ⊕ ▽

D

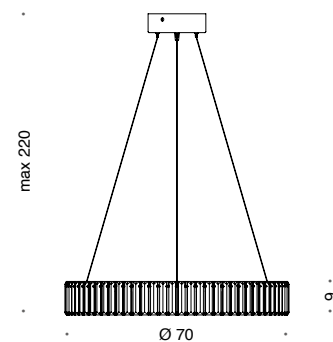

628/90
1 x STRIP LED
MAX 37W
4921 lumen 3000K
CE ⊕ ▽

D

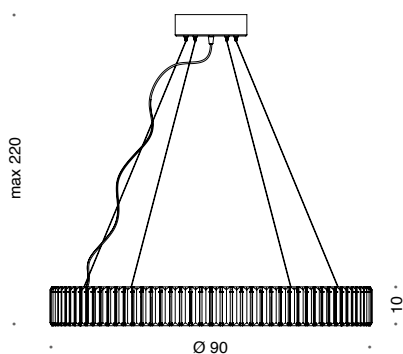

628/A
1 x Strip LED
5 W
665 lumen
3000K
CE ⊕ ▽

D

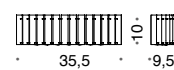

628/L
1 x Strip LED 9 W
1197 lumen - 3000K
CE ⊕ ▽

B

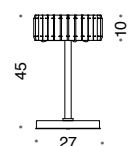



floritude

DESIGN **CRISTIAN FELTRIN**









floritude

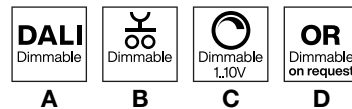

DESIGN **CRISTIAN FELTRIN**

Il telaio in metallo è disponibile nelle seguenti finiture:

- oro chiaro

- pure steel

Fiori in cristallo Asfour.

La collezione è decorata con cristalli trasparenti

Metal frame is available in the following finishes:

- light gold

- pure steel

Flowers in Asfour crystals.

The collection is decorated with transparent crystals

664/9
9 x LED 3,6W
3465 lumen - 3000 K
CE ⊕ ▽

D

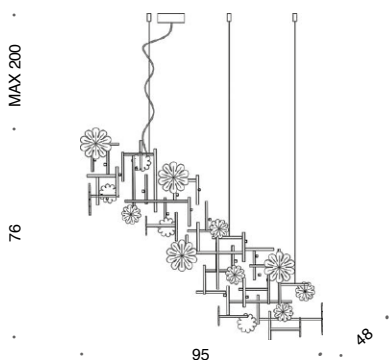

664/5
5 x LED 3,6W
1925 lumen - 3000 K
CE ⊕ ▽

D

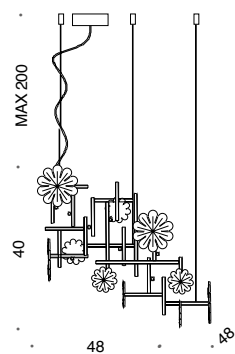



crystal blade

DESIGN CRISTIAN FELTRIN



512/1A
applique | wall bracket







260 | crystal blade

512/5SG
sospensione | suspension











512/5P
lampada da terra | floor lamp



2



1

- 1 512/1L
 - 2 512/2L
- lampada da tavolo | table lamp

crystal blade

DESIGN **CRISTIAN FELTRIN**

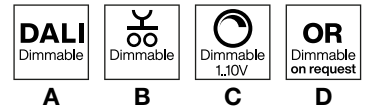

Telaio in metallo, disponibile nelle seguenti finiture:

- cromo
- oro chiaro
- black aubergine

Diffusori in vetro di Murano trasparenti.

La collezione è decorata con cristalli trasparenti.

Metal frame, available in the following finishes:

- chrome
- light gold
- black aubergine

Diffusers in transparent Murano glass.

The collection is decorated with transparent crystals

512/120

8 x G9 MAX 33W



D

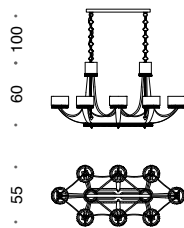

512/6+3

9 x G9 MAX 33W



D

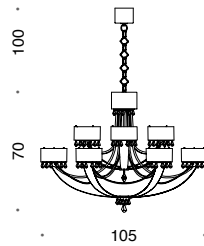

512/8

8 x G9 MAX 33W



D

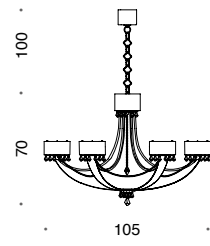

512/6

6 x G9 MAX 33W



D

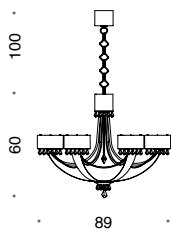

512/5SG

5 x G9 MAX 33W



D

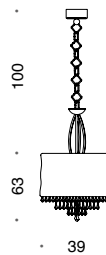

512/2A

2 x G9 MAX 33W



D

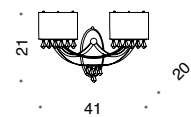

512/1A

1 x G9 MAX 33W



D

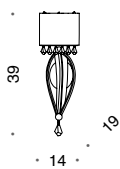

512/3A

3 x G9 MAX 33W



D

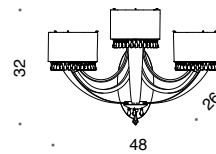

512/5P

5 x G9 MAX 33W



D

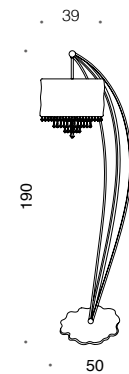

512/2L

2 x G9 MAX 33W



D

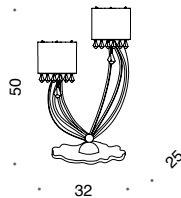

512/1L

1 x G9 MAX 33W



D

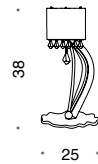



paradise

DESIGN **CRISTIAN FELTRIN**



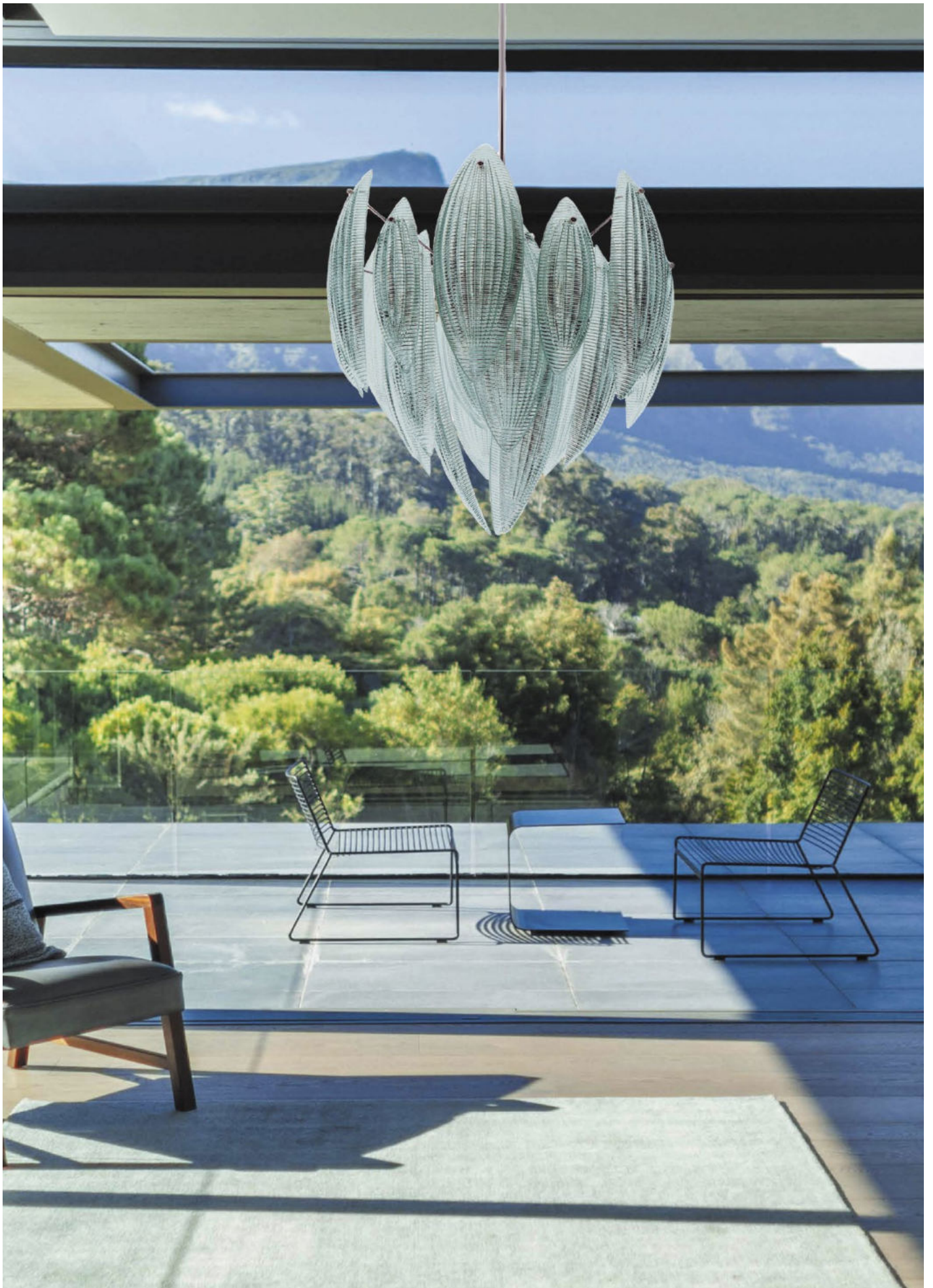

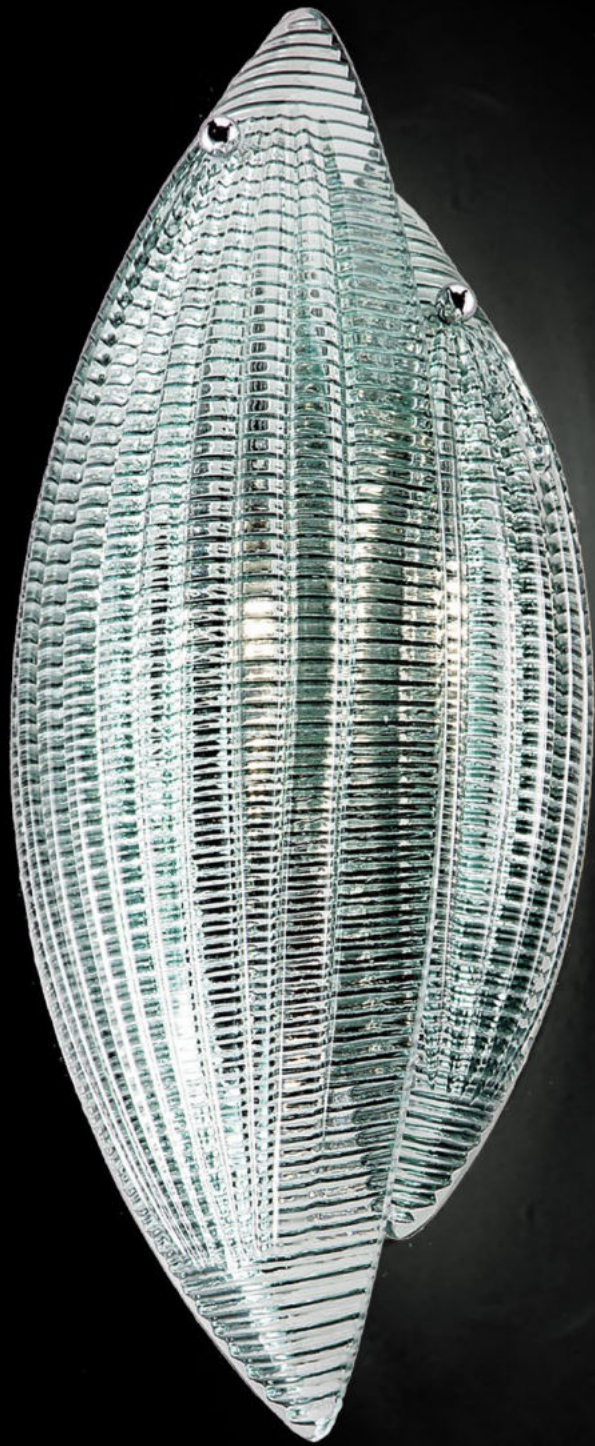





430/100
sospensione | suspension





1



2

- 1 **430/4A**
- 2 **430/2ADX**
applique | wall bracket





430/1L
lampada da tavolo | table lamp







paradise

DESIGN CRISTIAN FELTRIN

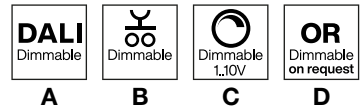

Telaio in metallo, disponibile con finitura cromo o oro chiaro. Le basi della lampada da terra e della lampada da tavolo sono in finitura nichel spazzolato.

Vetri in Murano disponibili nei seguenti colori:

- bianco latte
- foglia oro
- foglia argento
- trasparente
- bronzo
- acquamarina

Metal frame available in chrome or light gold finish. The bases of the floor lamp and table lamp are in brushed nickel frame finish.

Murano glass available in the following finishes:

- white
- gold leaf
- silver leaf
- transparent
- bronze
- aquamarine

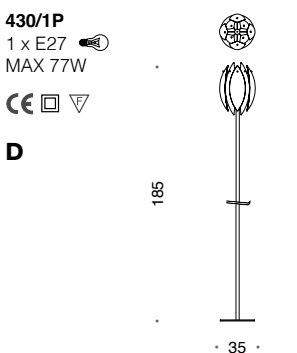
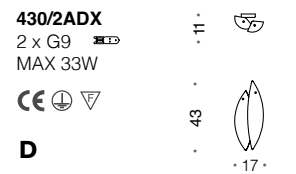
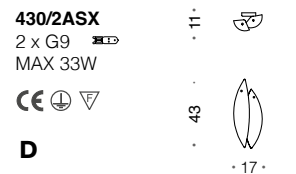
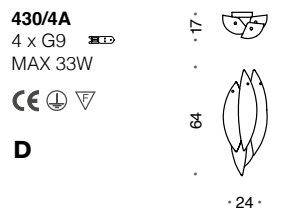
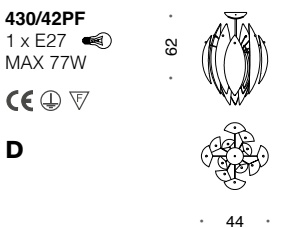
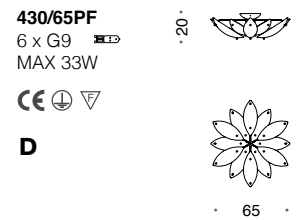
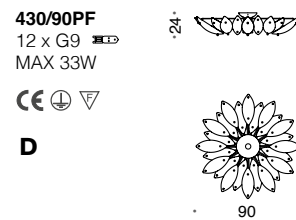
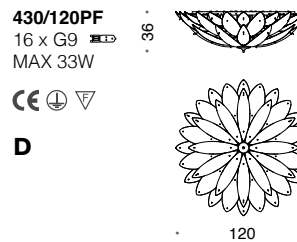
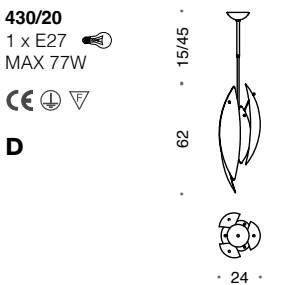
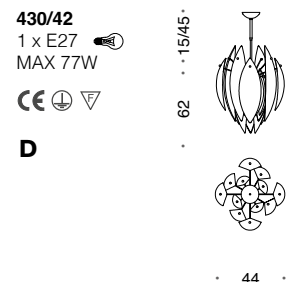
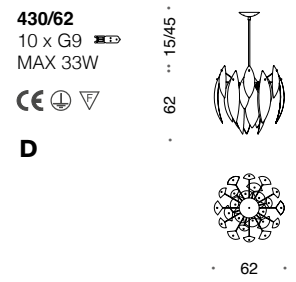
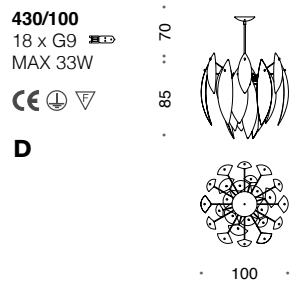
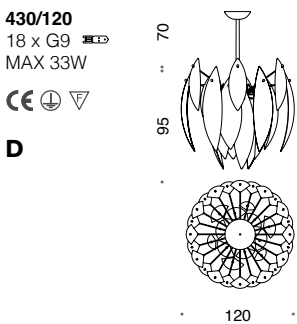



angel

DESIGN IDL STAFF



< 653/6+6
sospensione | suspension

653/1AP
applique | wall bracket



1 653/1SG
2 653/1SP
sospensione | suspension



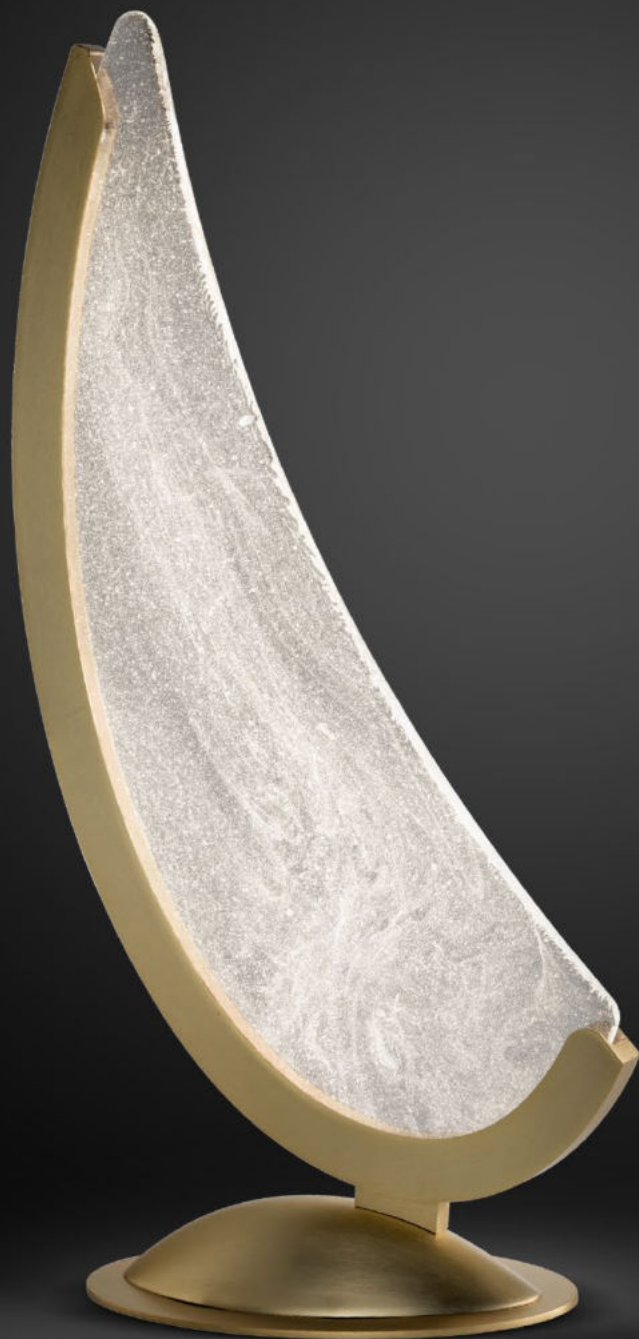

angel

DESIGN IDL STAFF



A



B



C



D

Il telaio in metallo è disponibile nelle seguenti finiture:

- oro chiaro spazzolato
- nichel spazzolato
- oro chiaro
- pure steel

Vetro di Murano trasparente pulegoso.

Metal frame is available in the following finishes:

- brushed matt light gold
- brushed nickel
- light gold
- pure steel

Pulegoso transparent Murano glass.

653/6+6

12 x STRIP LED
MAX 96W
13120 lumen - 3000 K



D

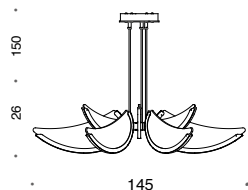

653/2+1S

3 x STRIP LED
MAX 26W
3506 lumen - 3000 K



D

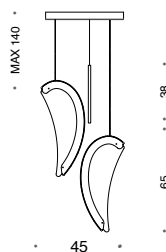

653/1SG

1 x STRIP LED
MAX 10W
1320 lumen - 3000 K



D

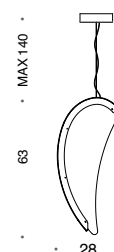

653/1SP

1 x STRIP LED
MAX 6W
867 lumen - 3000 K



D

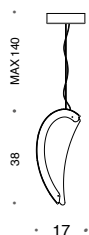

653/1AP

1 x LED
MAX 6W
867 lumen - 3000 K



D

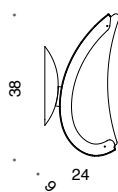

653/1LP

1 x LED
MAX 6W
867 lumen - 3000 K



D

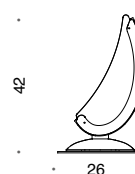

653/1LG

1 x LED
MAX 10W
1320 lumen - 3000 K



D

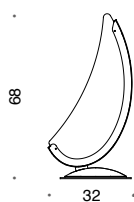



crystal moon

DESIGN CRISTIAN FELTRIN







2

1

1 475/1AG-PFG
2 475/1AP-PFP
applique | wall bracket







crystal moon



A



B



C



D

DESIGN **CRISTIAN FELTRIN**

Telaio in metallo oro chiaro.

Diffusori in vetro di Murano bianco lavorato con fascia in graniglia e con effetto battuto.

La collezione è decorata con cristalli.

Light gold metal frame.

White Murano glass diffusers worked with grit band and wrought effect.

The collection is decorated with crystals.

475/12
12 x G9
MAX 33W



D

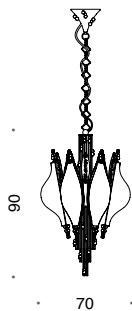

475/1SG
1 x E27
MAX 77W



D

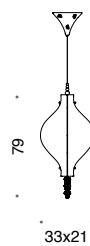

475/1SP
1 x E27
MAX 77W



D

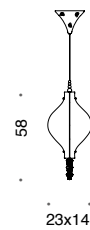

475/12PF
12 x G9
MAX 33W



D

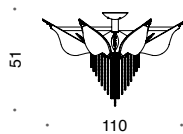

475/1AG-PFG
4xLED 5W
2300 lumen 2700K



D

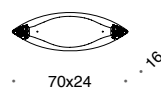

475/1AP-PFP
2xLED 5W
1150 lumen 2700K



D

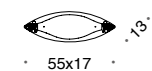

475/1L
1 x E27
MAX 77W



D

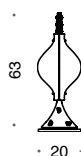



vanity

DESIGN CRISTIAN FELTRIN



584/1L
lampada da tavolo | table lamp



vanity

DESIGN **CRISTIAN FELTRIN**



A



B



C



D

La collezione è disponibile con le seguenti finiture:

art. 584: pure steel o oro chiaro abbinato con bronzo o nichel nero
paralume iuta chiaro o scuro e chinette avorio o tortora

art. 585: pure steel, bronzo, nichel nero, rame, oro chiaro,
paralume plissé avorio o bianco

Per la collezione 585 le sfere sono in metallo e vetro,
mentre nella serie 484 sono tutte in metallo.

The collection is available with the following finishes:

art. 584: pure steel or light gold combined with bronze or black nickel
lampshade in light or dark jute and ivory or dove grey chinette

art. 585: bronze, black nickel, coppery, light gold,
ivory or white plissé lampshade

For the collection 585 the spheres are in metal and
transparent glass, instead for the collection 484 the
spheres are all in metal.

585/1L

1 x E27
MAX 77W



D

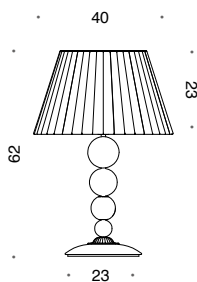

584/1L

1 x E27
MAX 77W



D

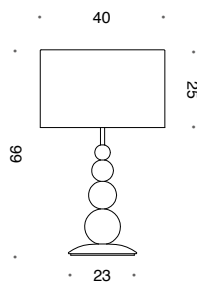



ninfea

DESIGN NICOLA DESIGN







436/5P
lampada da terra | floor lamp







ninfea



A



B



C



D

DESIGN **NICOLA DESIGN**

Telaio in metallo, disponibile con finitura cromata o oro chiaro.
Disponibile nella versione con perle in vetro di Murano bianco latte
oppure con cristalli trasparenti.

Metal frame, available in chrome or light gold finish.
Available with white Murano glass pearls or with transparent crystals.

436/18+1
19 x G9
MAX 33W



D

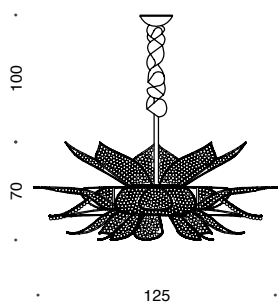

436/10+1
11 x G9
MAX 33W



D

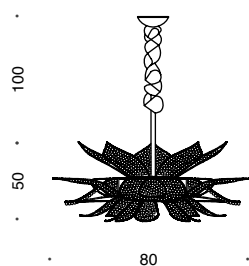

436/5P
5 x G9
MAX 33W



D

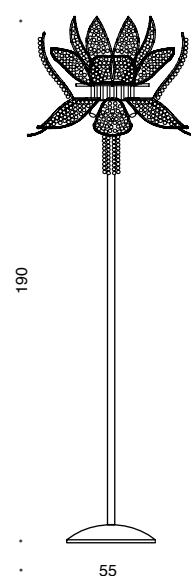

436/18+1PF
19 x G9
MAX 33W



D

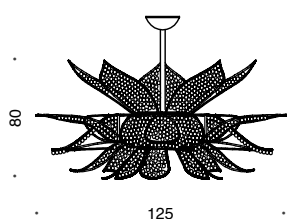

436/10+1PF
11 x G9
MAX 33W



D

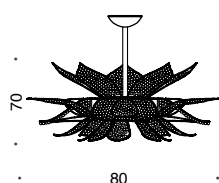

436/4+1A
4 x G9
MAX 33W
+ 1 LED x 1W
93 lumen
2800 K



D

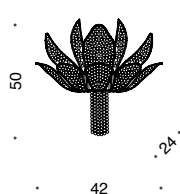

436/5L
5 x G4
MAX 10W



D

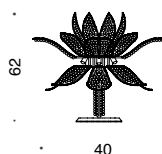

charme

DESIGN CRISTIAN FELTRIN

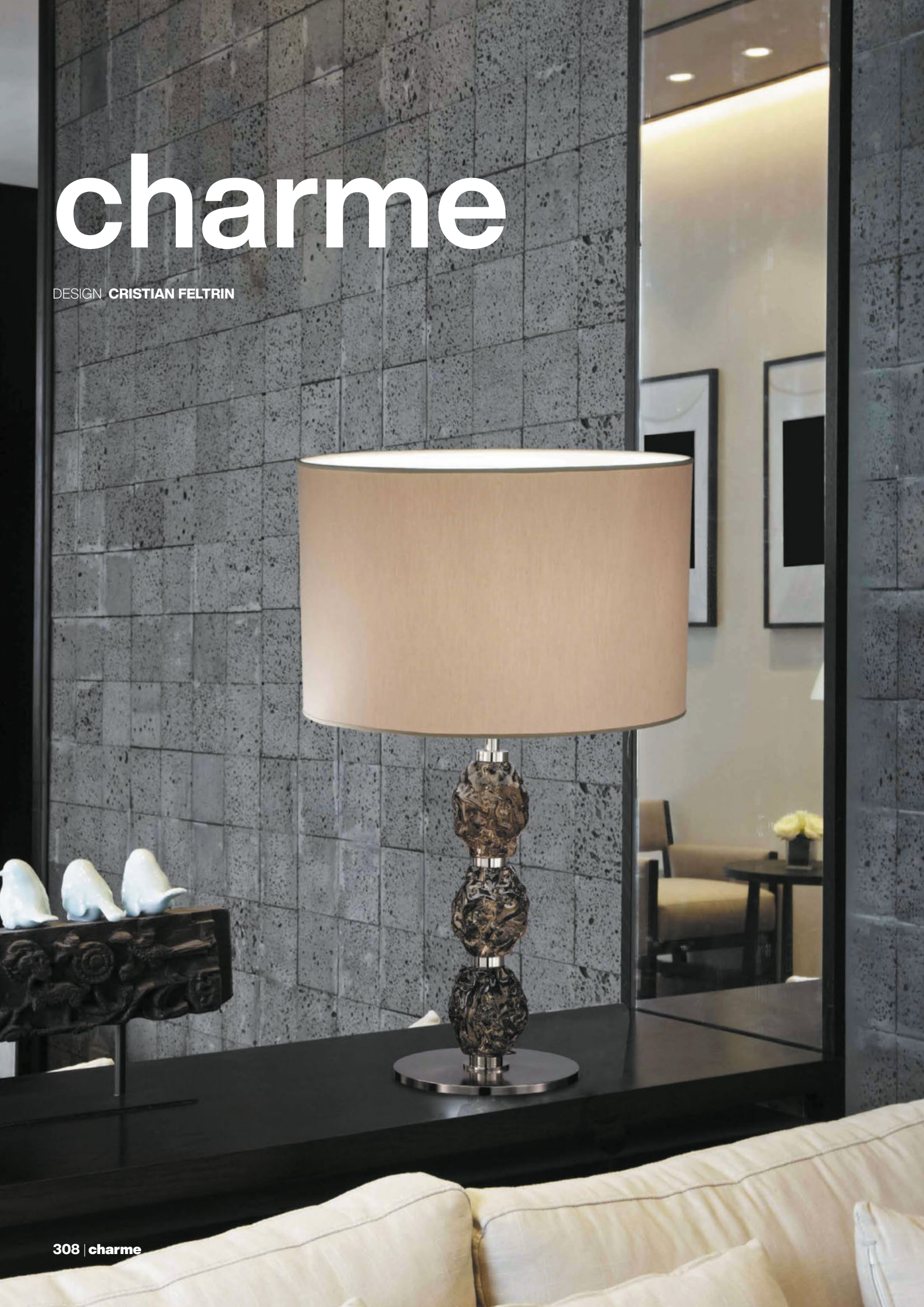



1



2

1 **600/1LG**
2 **600/1LP**
lampada da tavolo | table lamp





600/1LM
lampada da tavolo | table lamp





601/1LM
lampada da tavolo | table lamp





601/1LM
lampada da tavolo | table lamp



1



2

- 1 **600/9P**
 - 2 **600/7P**
- lampada da terra | floor lamp



600/13P
lampada da terra | floor lamp



charme



A



B



C



D

DESIGN **CRISTIAN FELTRIN**

Telaio in metallo disponibile in finiture:

pure steel, nichel nero, bronzo, rame, oro chiaro

Paralume disponibile in tessuto:

- chinette avorio o tortora

- juta chiaro o juta scuro

- plissé rosso, blu, verde, bianco, avorio

Vetro decorativo in Murano disponibile in colori:

cristallo, ambra, fumè, azzurro, verde, bianco o avorio.

Metal frame available in the following finishes:

pure steel, black nickel, bronze, coppery, light gold

Lampshade available with fabric:

- ivory or dove grey chinette

- light or dark jute

- red, blue, green, white or ivory plissé

Red, amber, smoke grey, light blue, green, white or black

decorative Murano glass.

601/1LG

1 x E27
MAX 77W



D

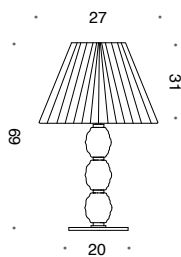

601/1LM

1 x E27
MAX 77W



D

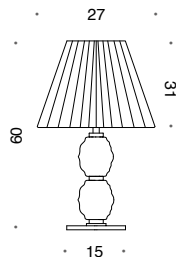

600/1LG

1 x E27
MAX 77W



D

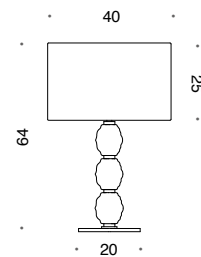

600/1LM

1 x E27
MAX 77W



D

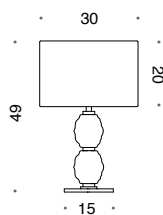

600/1LP

1 x E14
MAX 30W



D

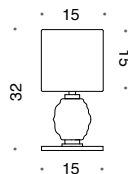

600/7P

1 x E27
MAX 77W



D

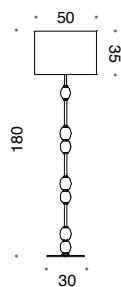

600/9P

1 x E27
MAX 77W



D

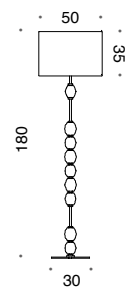

600/13P

1 x E27
MAX 77W



D

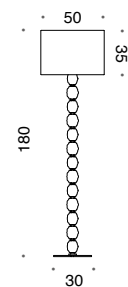



grace

DESIGN IDL STAFF



< 530/6+3
sospensione | suspension

530/6
sospensione | suspension



grace

DESIGN IDL STAFF

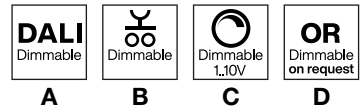

Telaio in metallo, disponibile nelle seguenti finiture:

- Bianco Velluto
- Nero Velluto
- Nickel Nero Spazzolato
- Cromo Spazzolato
- Oro Spazzolato

Paralumi in tessuto Lamè disponibili in Oro o Argento.

The metal frames available in the following finishes :

- Velvet White
- Velvet Black
- Brushed Black Nickel
- Brushed Chrome
- Brushed Gold

Fabric lampshades Lamè Gold or Silver

530/10+5

15 x E14
MAX 30W



D

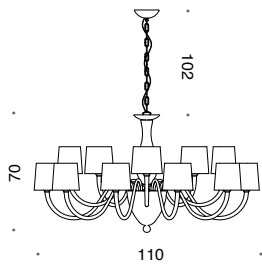

530/6+3

9 x E14
MAX 30W



D

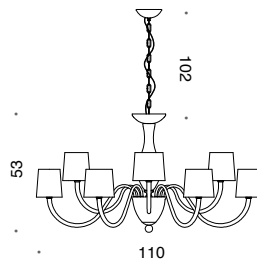

530/6

6 x E14
MAX 30W



D

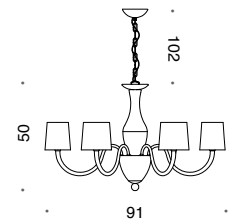

530/2A

2 x E14
MAX 30W



D

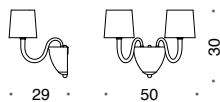



crystal rock

DESIGN **CRISTIAN FELTRIN**













crystal rock

DESIGN **CRISTIAN FELTRIN**

DALI
Dimmable

A

Y
Dimmable

B

C
Dimmable
1,10V

C

OR
Dimmable
on request

D

Telaio in metallo, disponibile nelle seguenti finiture:

- nero velluto
- pure steel
- oro chiaro
- ruggine

La collezione è decorata con cristalli trasparenti.

Metal frame, available in the following finishes:

- velvet black
- pure steel
- light gold
- rusty

The collection is decorated with transparent crystals.

476/4
4 x G9 
MAX 33W



D

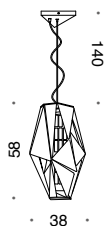

476/3
3 x G9 
MAX 33W



D

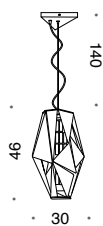

476/4PF
4 x G9 
MAX 33W



D



476/4A
4 x G9 
MAX 33W



D

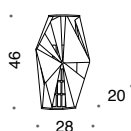

476/2L
2 x G9 
MAX 33W



D

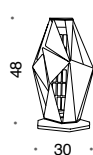

476/3L
3 x G9 
MAX 33W



D

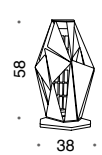



corten

DESIGN CRISTIAN FELTRIN

332 | corten

509/6
sospensione | suspension



1



2

- 1 **509/4**
 - 2 **509/8**
- sospensione | suspension











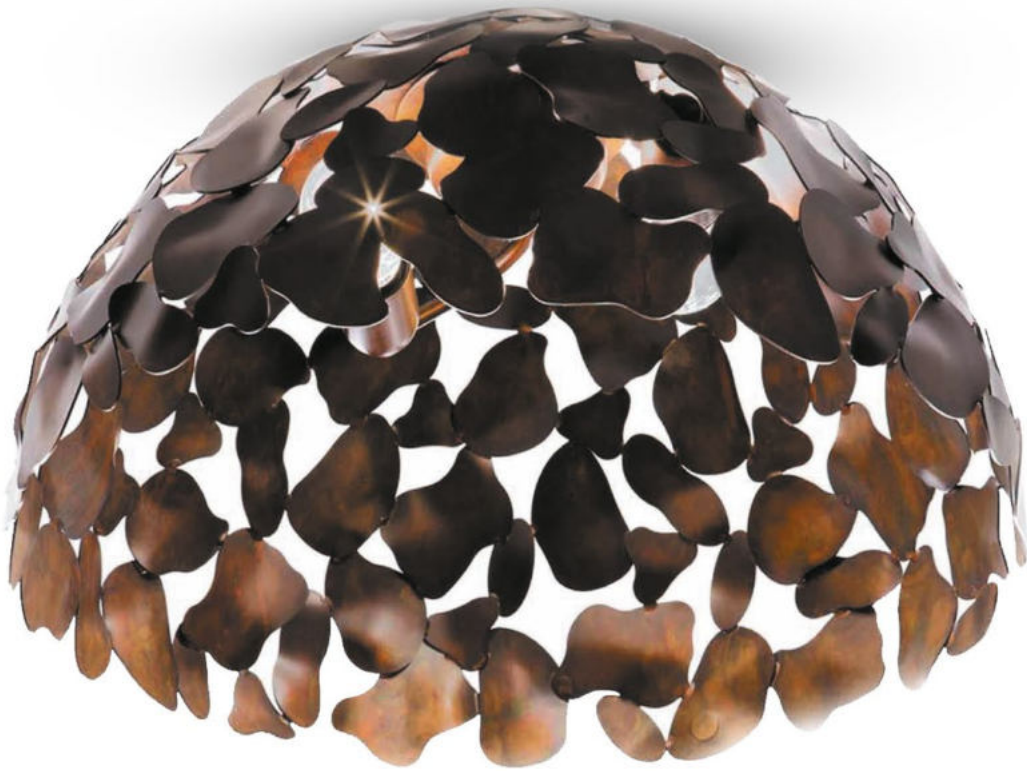

< 468/72/E
sospensione | suspension

468/50PF/E
plafoniera | ceiling lamp





468/1PFLED
plafoniera | ceiling lamp





469/3A
applique | wall bracket





509/16A-M
applique | wall bracket



1 **509/3L**
2 **509/4L**
lampada da tavolo | table lamp



509/4L
lampada da tavolo | table lamp





469/1L
lampada da tavolo | table lamp

corten

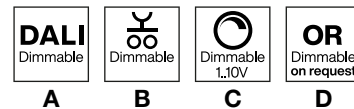

DESIGN **CRISTIAN FELTRIN**

La collezione è disponibile nei seguenti abbinamenti colore:

- argento corten con catene cromate
- marrone corten con catene oro chiaro.

La collezione è decorata con cristalli trasarenti.

The collection is available in the following colour combinations:

- silver corten with chromed chains
- brown corten with golden chains

The collection is decorated with transparent crystals

468/120LED
4 x striscia LED 46W
3456 lumen - 3200 K
CE ⊕ ▽

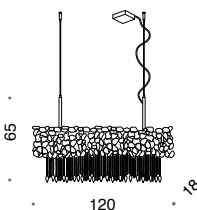

469/120
12 x G9
MAX 33W
CE ⊕ ▽

D

468/2LED
12xLED 2,3W
+ 2 LED 2,2W
CE ⊕ ▽

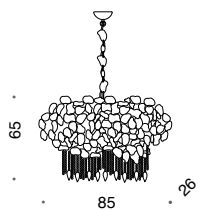

469/12
12 x G9
MAX 33W
CE ⊕ ▽

D

468/1LED
6xLED 2,3W 1782 lumen
+ 1 LED 2,2W 3000K
CE ⊕ ▽

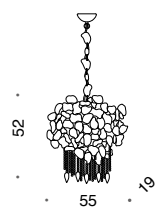

469/6
6 x G9
MAX 33W
CE ⊕ ▽

D

468/72/E
3 x E27
MAX 77W
CE ⊕ ▽

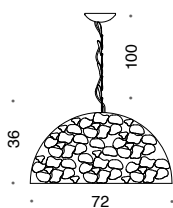

D

468/50/E
2 x E27
MAX 77W
CE ⊕ ▽

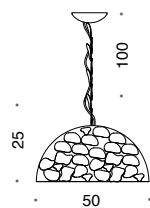

D

468/35/E
1 x E27
MAX 77W
CE ⊕ ▽

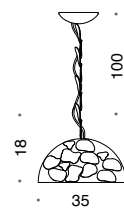

D

509/8
8 x G9
MAX 33W
CE ⊕ ▽

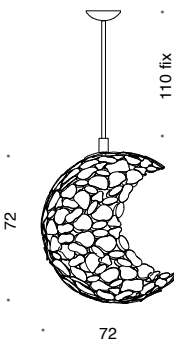

D

509/6
6 x G9
MAX 33W
CE ⊕ ▽

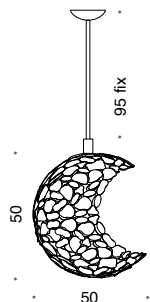

D

509/4
4 x G9
MAX 33W
CE ⊕ ▽

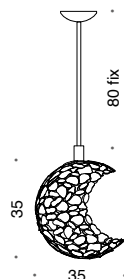

D

468/72PF/E
3 x E27
MAX 77W
CE ⊕ ▽

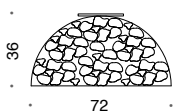

D

468/50PF/E
2 x E27
MAX 77W
CE ⊕ ▽

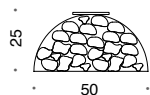

D

468/35PF/E
1 x E27
MAX 77W
CE ⊕ ▽

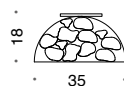

D

468/1PFLED

6xLED 2,3W 1782 lumen
+ 1 LED 2,2W 3000K

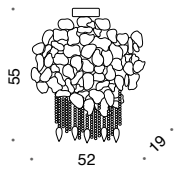

469/6PFG

6 x G9
MAX 33W



D

469/6PF

6 x G9
MAX 33W



D

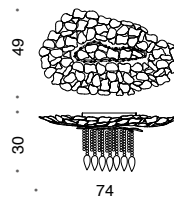

469/3A

3 x G9
MAX 33W



D

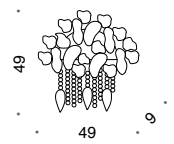

469/3AG

3 x G9
MAX 33W



D

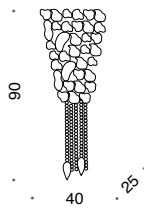

509/4A-G

glass

509/4A-M

metal

4 LED max 2,3W
1440 lumen - 3000 K



D

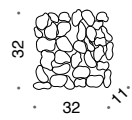

509/16A-G

glass

509/16A-M

metal

16 LED max 2,3W
3840 lumen - 3000 K



Punto di connessione
solo in **A** e **B**
Electrical connection in **A** or **B**
position only

D

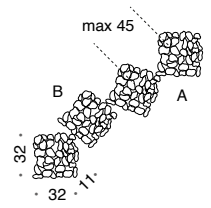

509/4L

4 x G9
MAX 33W



D

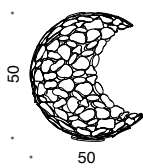

509/3L

3 x G9
MAX 33W



D



468/PLED

2 x striscia LED 40,5W
3024 lumen - 3000 K



D

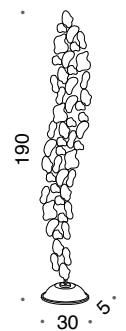

469/1L

1 x G9
MAX 33W



D

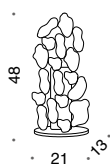



amalfi

DESIGN CRISTIAN FELTRIN

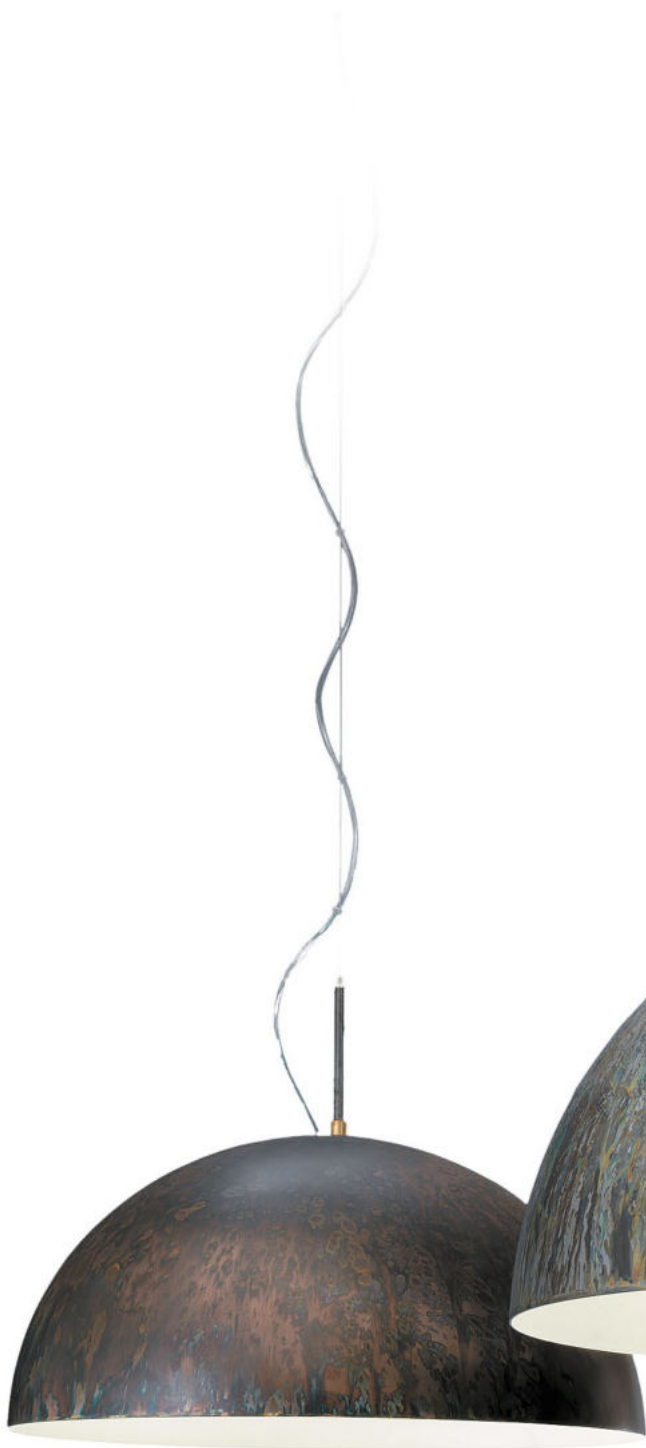

1



2

- 1 **482/50**
 - 2 **482/72**
- sospensione | suspension





482/50
sospensione | suspension

amalfi | 355







1 **482/35PF**
2 **482/50PF**
plafoniera | ceiling lamp

amalfi

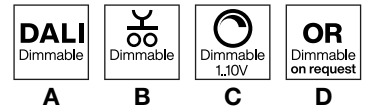

DESIGN **CRISTIAN FELTRIN**

Telaio in metallo disponibile nelle finiture come da cartella colore. L'interno di ogni articolo è disponibile nei colori bianco satinato, foglia oro o foglia argento. Diffusore in policarbonato satinato.

Nota: nelle sospensioni con 1 x E27 il diffusore non è applicato.

Metal frame available in finishes as per colour card. The inside of each items is available in the colours satin white, gold or silver leaf.

Satin polycarbonate diffuser.

Note: on suspensions with 1 x E27 the diffuser is not applied.

482/90
12 x LED 2,3W
3564 lumen - 2700K
CE ⊕ ▽

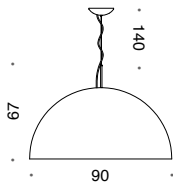

478/90/E
4 x E27
MAX 46W
CE ⊕ ▽

D

482/72
10 x LED 2,3W
2970 lumen - 2700K
CE ⊕ ▽

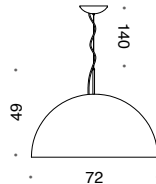

478/72/E
3 x E27
MAX 46W
CE ⊕ ▽

D

482/50
8 x LED 2,3W
2376 lumen - 2700K
CE ⊕ ▽

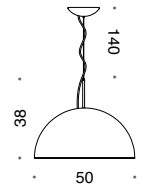

478/50/E
2 x E27
MAX 30W
CE ⊕ ▽

D

482/35
4 x LED 2,3W
1188 lumen - 2700K
CE ⊕ ▽

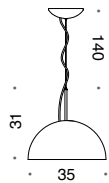

478/35/E
1 x E27
MAX 30W
CE ⊕ ▽

D

482/90PF
12 x LED 2,3W
3564 lumen - 2700K
CE ⊕ ▽

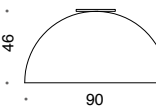

478/90PF/E
4 x E27
MAX 46W
CE ⊕ ▽

D

482/72PF
10 x LED 2,3W
2970 lumen - 2700K
CE ⊕ ▽

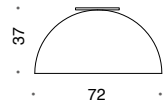

478/72PF/E
3 x E27
MAX 46W
CE ⊕ ▽

D

482/50PF
8 x LED 2,3W
2376 lumen - 2700K
CE ⊕ ▽

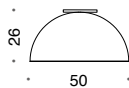

478/50PF/E
2 x E27
MAX 30W
CE ⊕ ▽

D

482/35PF
4 x LED 2,3W
1188 lumen - 2700K
CE ⊕ ▽

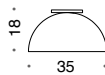

478/35PF/E
1 x E27
MAX 30W
CE ⊕ ▽

D



bamboo

DESIGN CRISTIAN FELTRIN

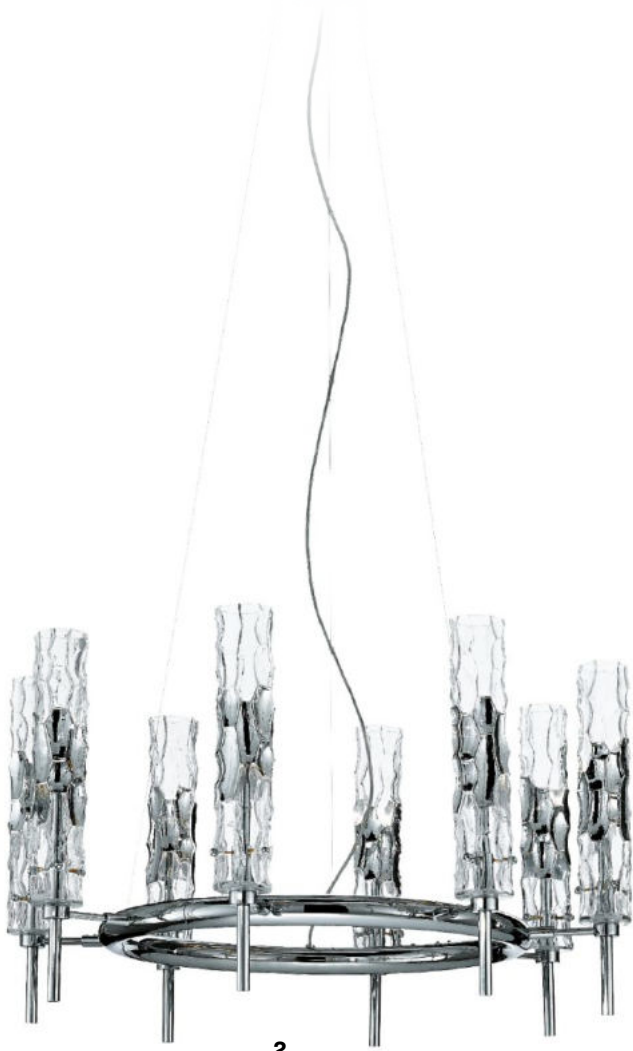

2



1

- 1 **497/12**
 - 2 **497/8**
- sospensione | suspension









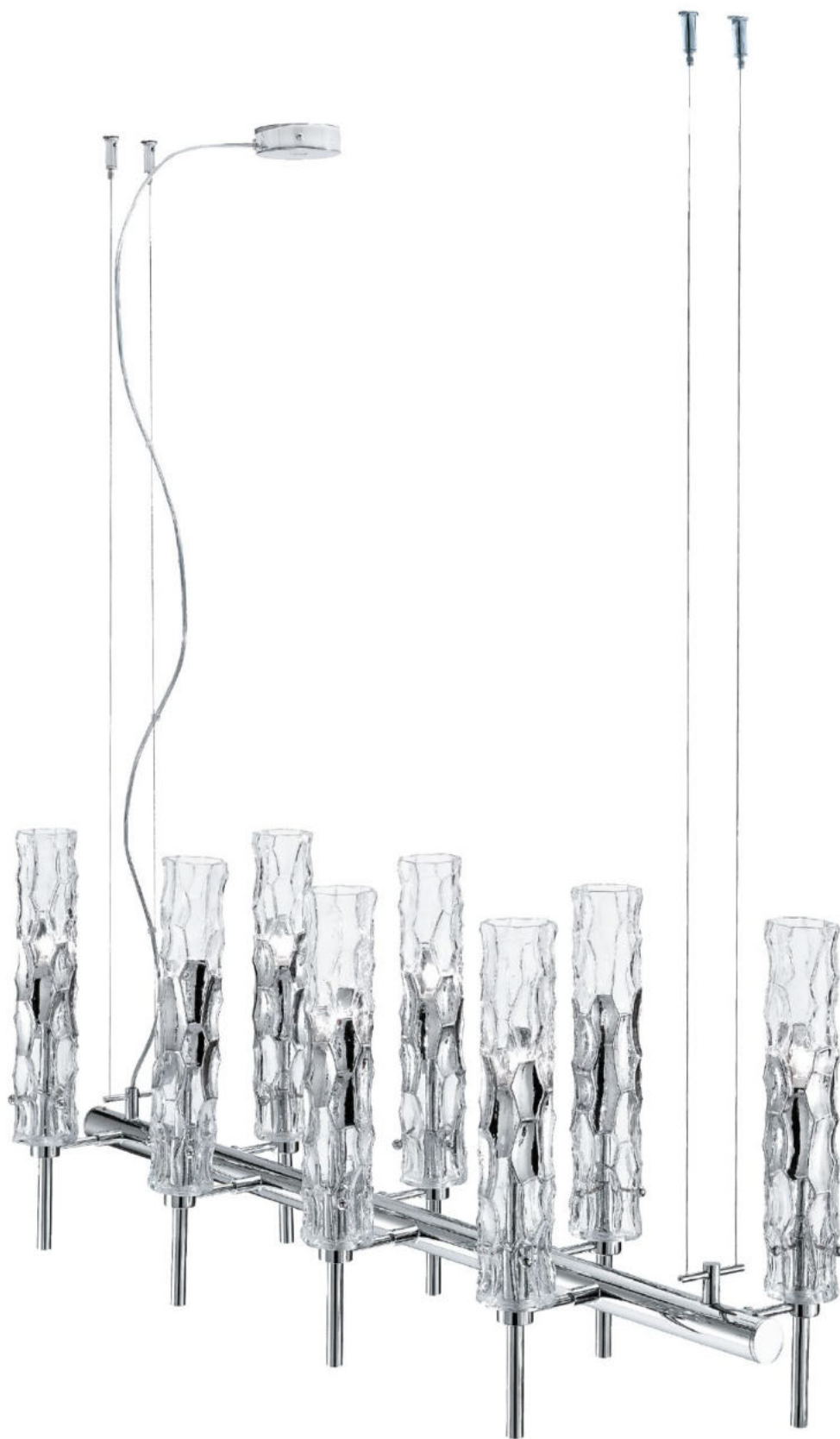









1 423/3L

2 423/1L

lampada da tavolo | table lamp



423/6PF
plafoniera | ceiling lamp







1 **423/2ADX**
2 **423/2ASX**
applique | wall bracket



423/1A
applique | wall bracket



1



2

- 1 **423B/1LG**
2 **423B/1LP**
lampada da tavolo | table lamp



423/3P
lampada da terra | floor lamp





2

1

1 423B/5P
2 423B/4P
lampada da terra | floor lamp

bamboo

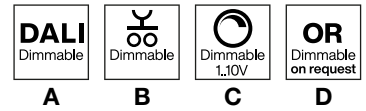

DESIGN **CRISTIAN FELTRIN**

Telaio in metallo disponibile nelle seguenti finiture:

- cromo, placcato oro 24kt, nichel nero satinato, nichel nero

Tubi in vetro di Murano lavorato con effetto martellato disponibile:

- con fascia decorativa metallizzata cromo o oro

- completamente metallizzato cromo

- completamente trasparente

Nelle sospensioni a cavo, i cavi sono in acciaio inox.

I paralumi in tessuto sono disponibili nelle seguenti varianti:

- chiette avorio, lamé argento o oro.

Metal frame available in the following finishes:

- chrome finish, 24kt gold plated, satin black nickel, black nickel

Tubes in Murano glass worked with hammered effect available:

- with decorative band chrome or gold

- all in chrome

- all in clear

In the suspensions with cables, the cables are in stainless steel.

Fabric lampshades are available in the following versions:

- chiette ivory, lamé silver or gold

497/8+8
16 x G9
MAX 20W
CE ⊕ ▽

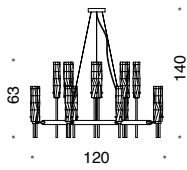

D

497/12
12 x G9
MAX 20W
CE ⊕ ▽

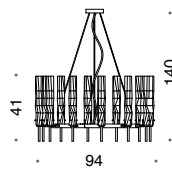

D

497/8
8 x G9
MAX 20W
CE ⊕ ▽

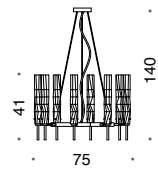

D

496/8
8 x G9
MAX 20W
CE ⊕ ▽

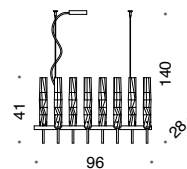

D

423/12
12 x G9
MAX 20W
CE ⊕ ▽

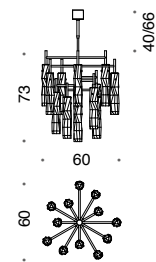

D

423/8
8 x G9
MAX 20W
CE ⊕ ▽

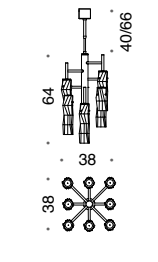

D

423/6
6 x G9
MAX 20W
CE ⊕ ▽

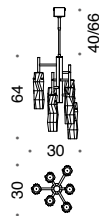

D

423/3
3 x G9
MAX 20W
CE ⊕ ▽

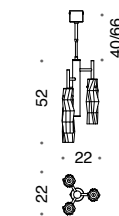

D

423/1S
1 x G9
MAX 20W
CE ⊕ ▽

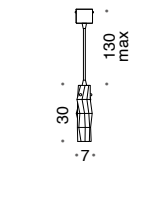

D

423/10PF
10 x G9
MAX 20W
CE ⊕ ▽

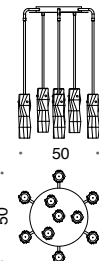

D

423/8PF
8 x G9
MAX 20W
CE ⊕ ▽

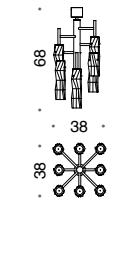

D

423/6PF
6 x G9
MAX 20W
CE ⊕ ▽

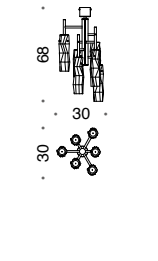

D

423/3PF
3 x G9
MAX 20W
CE ⊕ ▽

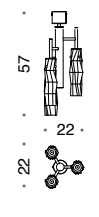

D

423/12PF
12 x G9
MAX 20W
CE ⊕ ▽

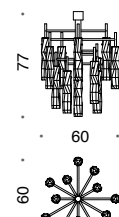

D

423/1A
1 x G9
MAX 20W
CE ⊕ ▽

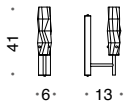

D

423/2ADX
2 x G9
MAX 20W
CE ⊕ ▽

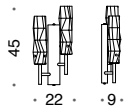

D

423/2ASX
2 x G9
MAX 20W
CE ⊕ ▽

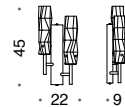

D

423/3A
3 x G9
MAX 20W
CE ⊕ ▽

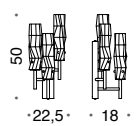

D

423/3L
3 x G9
MAX 20W
CE ⊕ ▽

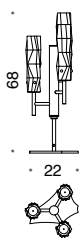

D

423/1L
1 x G9
MAX 20W
CE ⊕ ▽

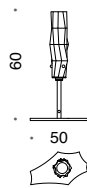

D

423B/1LG
1 x E27
MAX 77W
CE ⊕ ▽

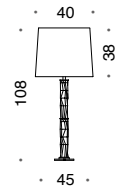

D

423B/1LP
1 x E27
MAX 77W
CE ⊕ ▽

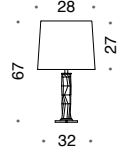

D

423/3P
3 x G9
MAX 20W
CE ⊕ ▽



D

423B/5P
1 x E27
MAX 77W
CE ⊕ ▽

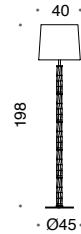

D

423B/4P
1 x E27
MAX 77W
CE ⊕ ▽

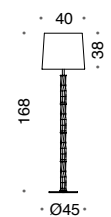

D

423/35
6 x GU10 LED
MAX 4,6W
2700K
CE ⊕ ▽

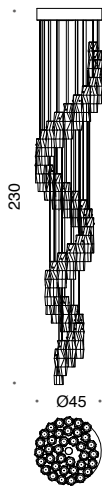

D

423/66
9 x GU10 LED
MAX 4,6W
2700K
CE ⊕ ▽

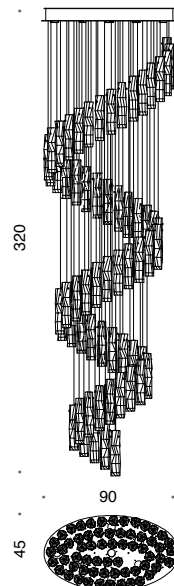

D

A+++

classi energetiche energy classes

Attacco Bulb type	Questo dispositivo è compatibile con lampadine di classi energetiche: This luminaire is compatible with bulbs of the energy classes	Il dispositivo è venduto con una lampadina di classe energetica: This luminaire is sold with bulbs of the energy classes:	Collezioni Collection
G9	da A++ a E from A++ to E	-	bamboo, chrysalis, corten, crystal, blade, crystal moon, crystal rock, crystalline, elite, groovy, leaves, ninfea, paradise, roma, weave
E27 E14	da A++ a E from A++ to E	-	amalfi, bamboo, charme, chrysalis, corten, crystal moon, grace, groovy, paradise, roma, vanity, weave
LED	da A++ a A from A++ to A	Le lampade di questo dispositivo non sono sostituibili The lamps cannot be changed in the luminaire	dp, miox, marea, acropora, amalfi, angel, artic, cesare, chrysalis, corten, crystal moon, crystalline, diamante, elite, eklè, floritude, flower miu, groovy, ice rain, leaves, miu, ninfea, tribù
GU10 LED	A+	-	bamboo, chrysalis, groovy
G4	A++	-	ninfea

simbologie symbols



La marcatura CE è la certificazione che definisce che tutti i prodotti IDL Export Srl sono verificati secondo le normative europee di sicurezza, in base alle norme seguenti:

The CE mark is the certification which defines that all products of IDL Export Srl are conforming the European security regulations, as per following rules:

- CEI EN 60598-1** prescrizione generali e prove / general requirements and tests
- CEI EN 60598-2-1** apparecchi di illuminazione fissi per uso generale / fixed lighting equipments for general use
- CEI EN 60598-2-4** apparecchi di illuminazione mobili per uso generale / mobile lighting equipments for general use
- CEI EN 60598-2-6** apparecchi di illuminazione con trasformatore incorporato per lampade ad incandescenza / lighting equipments with built-in transformer for incandescent lamps



La marcatura UKCA (UK Conformity Assessed) è il nuovo marchio di prodotto del Regno Unito che deve essere utilizzato per i prodotti immessi sul mercato in Gran Bretagna (Inghilterra, Galles e Scozia) a dimostrazione della conformità degli stessi alle normative tecniche in vigore in UK.

The UKCA (UK Conformity Assessed) marking is the new UK product mark that must be used for products placed on the market in Great Britain (England, Wales and Scotland) to demonstrate their compliance with the technical regulations in force in the UK).



Il certificato di conformità è una attestazione di conformità che conferma (certifica) con il marchio apposto sui prodotti che questi sono stati considerati e valutati conformi ai Regolamenti Tecnici dell'Unione Doganale euroasiatica (TR-TC).

The certificate of conformity is a certificate of conformity which confirms (certifies) with the mark affixed to the products that they have been considered and assessed as compliant with the Technical Regulations of the Eurasian Customs Union (TR-TC).



Indica la resistenza offerta dall'apparecchio alla penetrazione di solidi e liquidi, denominata con il codice IP (International Protection) e seguita da due cifre, 2 che indica il grado di protezione contro l'ingresso di corpi solidi (protetto per corpi di dimensioni superiori a 12mm) e 0, che indica il grado di protezione contro l'ingresso di corpi liquidi (non protetto).

Indicates the resistance given by the lighting fitting to the penetration of solids and liquids, stated by the code IP (International Protection) and followed by two digits, 2 which means the rate of protection against the entry of solid parts (protected against entry of solid parts with dimensions more than 12mm), and 0, which indicates the rate of protection against the entry of liquid parts (not protected).



CLASSE I Apparecchi con parti metalliche costantemente collegate al circuito terra

Equipments with metal parts constantly connected to the earth circuit.



CLASSE II Apparecchi provvisti di doppio isolamento o isolamento rinforzato e senza dispositivi di messa a terra

Equipments provided with double insulation or reinforced insulation without earthing devices



CLASSE III Apparecchi alimentati con tensione di sicurezza inferiore ai 50V

Equipments powered with safety voltage lower than 50V.



Apparecchi idonei a essere montati su superfici normalmente infiammabili

Equipments suitable to be fitted on normally inflammable surfaces.



Regolabile con segnale 1÷10 analogico, DALI

Adjustable with 1÷10 analog signal, DALI



Accensione, spegnimento e regolazione con pulsante (linea a bassa tensione)

Switching on, off and regulation with button (low voltage line)



Prodotti assoggettati alla normativa RAEE/WEEE (2002/96/CE)

Products according to the rules RAEE/WEEE (2002/96/CE)



Tutti i modelli sono depositati

All designs registered



condizioni generali di vendita

CONDIZIONI GENERALI DI VENDITA DI AZIENDA S.P.A. valide ed applicabili dal 01/01/2017

1. Premessa

Le presenti Condizioni Generali di Vendita di IDL EXPORT SRL, con sede legale in Via San Marco n.2, 31050 Fanzolo di Vedelago (TV) Italia, C.F. e P. IVA 03247000262 (di seguito "AZIENDA") regolano tutte le vendite dei prodotti realizzati e/o commercializzati da AZIENDA stessa (di seguito "Prodotti") ai propri clienti (di seguito gli "Acquirenti"), se non espressamente derogate per iscritto. Le presenti Condizioni Generali di Vendita sostituiscono ogni altro impegno, contratto o intesa, scritta o verbale, intervenuto/a in precedenza fra AZIENDA e l'Acquirente. In nessun caso si intenderanno applicabili altre condizioni di qualsiasi natura apposte su ordini e/o altri documenti inviati dall'Acquirente o da terzi, salvo espressa accettazione scritta di AZIENDA.

2. Conclusione del Contratto

L'ordine trasmesso dall'Acquirente diverrà impegnativo solo se effettuato per iscritto, anche via fax o mezzo mail. Il contratto si intende perfezionato esclusivamente quando l'Acquirente abbia ricevuto la conferma d'ordine scritta di AZIENDA, ovvero nel momento in cui AZIENDA inizi a dare esecuzione all'ordine trasmesso dall'Acquirente. Qualora la conferma d'ordine trasmessa da AZIENDA all'Acquirente contenga modifiche rispetto all'ordine, le modifiche si considereranno tacitamente accettate trascorsi 5 (cinque) giorni lavorativi dal ricevimento della conferma d'ordine senza che l'Acquirente abbia manifestato il proprio dissenso per iscritto.

3. Consegna e spedizione

Ove non diversamente pattuito nel Contratto, i Prodotti sono consegnati EXW (Incoterms® 2010) presso la sede legale di AZIENDA sita in 31050 Fanzolo di Vedelago (TV) via San Marco n. 2 - ITALIA - (in seguito denominata "Consegna"). Salvo diverso accordo scritto, l'Acquirente dovrà ritirare i Prodotti entro e non oltre 8 (otto) giorni. In caso di ritardo nel ritiro dei Prodotti, i termini di pagamento concordati non subiranno alcuna proroga e l'Acquirente si farà carico di tutte le spese relative all'occupazione dei magazzini di AZIENDA ammontanti ad un importo fisso giornaliero pari allo 0,5% del prezzo netto dei Prodotti. Resta inteso che il rischio di danneggiamento, deperimento, perdita e/o furto degli stessi graverà sull'Acquirente a partire dalla data di Consegna inizialmente convenuta. L'Azienda provvederà ad imballare i prodotti con un imballaggio standard per normali trasporti e movimentazioni. Qualora si rendessero necessari imballaggi particolari, questi ultimi verranno fatturati al costo secondo gli accordi intervenuti di volta in volta con l'Acquirente. In nessun caso i termini di consegna convenuti nel Contratto (di seguito "Termini di Consegna") assumono carattere di termine essenziale. Qualora sia previsto un anticipo all'ordine, l'apertura di una lettera di credito o il rilascio di una garanzia bancaria, i termini di consegna inizieranno a decorrere dal ricevimento dell'anticipo o dei documenti comprovanti l'operatività della lettera di credito o della garanzia. I termini di cui sopra restano, inoltre, sospesi fino alla comunicazione da parte dell'Acquirente di tutti i dati tecnici ed amministrativi necessari per la corretta evasione dell'ordine. I termini di consegna si intendono automaticamente prorogati in caso di modifiche alla fornitura richieste dall'Acquirente successivamente alla conclusione del contratto e si intendono automaticamente sospesi in caso di mancato pagamento da parte dell'Acquirente di qualsiasi importo dovuto a AZIENDA, anche se non relativo alla fornitura in oggetto. Eventuali ritardi nella Consegna inferiori o uguali a 30 (trenta) giorni rispetto al Termine di Consegna convenuto o prorogato non possono in alcun caso dar luogo a pretese di risarcimento danni o di riduzione del prezzo, né ad annullamento e/o risoluzione e/o modifica del Contratto. In caso di ritardo nella Consegna superiore di 60 (sessanta) giorni, l'Acquirente avrà diritto a una penale giornaliera pari a EUR 50,00 (cinquanta/00), a decorrere dal sessantunesimo giorno e fino alla data di consegna effettiva; l'Acquirente rinuncia espressamente a richiedere il maggior danno, a pretese di riduzione del prezzo, a richiedere l'annullamento e/o la risoluzione e/o la modifica del Contratto. In caso di ritardi nella Consegna dei Prodotti determinati da caso fortuito, forza maggiore, ritardi o mancate consegne dei propri fornitori e/o altre cause non imputabili a dolo e/o colpa grave o comunque qualsiasi altra causa al di fuori del ragionevole controllo di AZIENDA, l'Acquirente non avrà titolo per richiedere alcun indennizzo e/o risarcimento del danno, né per richiedere la risoluzione e/o la modificazione e/o l'annullamento del Contratto o la riduzione del prezzo dei Prodotti forniti.

4. Prezzi e termini di pagamento

Salvo diversa indicazione contenuta nella conferma d'ordine, i prezzi dei Prodotti sono quelli risultanti dal listino prezzi di AZIENDA in vigore al momento della conferma ed espressi in Euro. Il pagamento dovrà essere effettuato secondo le modalità di pagamento indicate da AZIENDA nella conferma d'ordine. In ogni caso, il Venditore si riserva il diritto di aumentare il prezzo pattuito prima della consegna, al fine di coprire i maggiori costi dei Beni dovuti a cause estranee alla volontà del Venditore. I Prodotti rimangono di proprietà di AZIENDA sino ad integrale pagamento del prezzo o ad integrale incasso di eventuali assegni, cambiali, o mezzi di pagamento negoziabili, anche se i documenti di trasporto sono stati già consegnati. In caso di mancato pagamento, anche parziale, del prezzo, AZIENDA avrà facoltà di sospendere l'esecuzione del Contratto sino all'integrale pagamento delle somme dovute, o alla prestazione di idonee garanzie. In caso di ritardo nel pagamento, anche parziale, AZIENDA avrà diritto al pagamento degli interessi di mora previsti dalla legge applicabile (D.Lgs. n. 231/2002 e successive modifiche), che in ogni caso cominceranno a decorrere automaticamente dal di della debenza senza alcuna necessità di formale costituzione in mora. In nessun caso, eventuali vizi dei Prodotti, quando anche espressamente riconosciuti da AZIENDA, nonché eventuali ritardi rispetto ai Termini di Consegna, conferiranno all'Acquirente la facoltà di sospendere i relativi pagamenti, e/o qualsiasi altro pagamento dovuto a AZIENDA in forza del presente Contratto o di altri rapporti contrattuali.

5. Garanzia e reclami - Resi - Listino/i

AZIENDA garantisce l'assenza di vizi nei Prodotti ai sensi di legge. Qualora gli eventuali reclami dell'Acquirente in ordine alla presenza di vizi nei Prodotti risultino fondati e accettati da AZIENDA nel periodo di garanzia, AZIENDA provvederà gratuitamente alla sostituzione dei Prodotti viziati e/o, a propria insindacabile discrezione, alla riparazione degli stessi con consegna effettuata EXW (Incoterms® 2010) presso la sede legale di AZIENDA. Resta inteso che l'obbligo di garanzia assunto da AZIENDA si intende limitato ai soli vizi dei Prodotti espressamente riconosciuti ed accettati da AZIENDA. Al momento del ricevimento l'Acquirente dovrà esaminare immediatamente i singoli Prodotti. A pena di decadenza dalla garanzia, l'Acquirente dovrà denunciare i vizi riscontrati nei Prodotti per iscritto. La presente garanzia all'Acquirente copre unicamente i difetti di materiale o lavorazione dei Prodotti ed in normali condizioni di utilizzo, trasporto, stoccaggio, conservazione, esposizione e vendita. Inoltre la presente garanzia sarà operativa soltanto a condizione che: 1) l'Acquirente non sia in ritardo con alcun pagamento, neppure per forniture diverse da quella relativa ai Prodotti difettosi; 2) i Prodotti siano utilizzati nell'ambito di un uso consentito per le loro caratteristiche tecniche e nel rispetto ed entro i limiti indicati nelle istruzioni per l'installazione; 3) i Prodotti siano installati da tecnici qualificati nel rispetto delle istruzioni per l'installazione fornite e delle normative tecniche; 4) i Prodotti siano alimentati con dispositivi di alimentazione forniti da AZIENDA e, ove previsto, installati nelle casseforme di AZIENDA; 5) l'installazione del prodotto sia certificata dall'installatore in conformità alle norme vigenti; 6) i prodotti siano stati modificati, manomessi o riparati da parte di terzi che non hanno ricevuto l'autorizzazione preventiva da AZIENDA; 7) i vizi del prodotto siano dovuti a eventi imprevedibili o non ragionevolmente probabili, comprese scariche elettriche, fulmini o correnti elettrostatiche; 8) l'impianto elettrico operi in un ambiente le cui caratteristiche non sono conformi a quelle necessarie per un corretto funzionamento in base alla tipologia e destinazione del Prodotto, tra cui, a titolo di esempio, disturbi di linea impulsivi, sbalzi di tensione, eccessiva temperatura o areazione insufficiente. In particolare e senza limitazione per la generalità di quanto precede, la garanzia non si estende ai Prodotti usati o di seconda mano, ai difetti dei Prodotti causati da inadeguate modalità di stoccaggio, trasporto, conservazione, manutenzione, esposizione o vendita adottate dall'Acquirente (o da terzi) ovvero ai difetti del Prodotto imputabili a colpa dell'Acquirente (o di terzi) o al mancato rispetto delle istruzioni ed indicazioni d'uso fornite da AZIENDA. L'Acquirente dichiara e riconosce che le informazioni e/o i dati e/o le immagini e/o le diciture dei Prodotti, indicati nel/i Listino/i di AZIENDA e/o nel sito web www.AZIENDA.it e/o in altro materiale di natura tecnica e/o commerciale e/o promozionale, hanno natura meramente indicativa. AZIENDA si riserva espressamente il diritto di modificare, in qualsiasi tempo e senza preavviso, le specifiche, i modelli, i materiali, i colori, gli accessori, le finiture e in generale qualsivoglia caratteristica dei Prodotti indicati nel/i Listino/i e/o nei suddetti siti Internet e/o in altro materiale di natura tecnica e/o commerciale e/o promozionale. Eventuali restituzioni dei Prodotti dovranno essere sempre preventivamente autorizzate per iscritto da AZIENDA. L'Acquirente sarà quindi tenuto a dare preavviso scritto a AZIENDA della spedizione dei Prodotti in restituzione, che dovrà essere tassativamente effettuata DDP (Incoterms 2010) sede di AZIENDA.

6. Oneri

Eventuali tasse, imposte, dazi, tributi, licenze, autorizzazioni, permessi e/o altri oneri di natura fiscale e/o doganale e/o amministrativa comunque denominati, previsti dalla normativa dello Stato di importazione dei Prodotti oggetto del Contratto (d'ora in poi, "Oneri"), sono interamente ed esclusivamente a cura e a carico dell'Acquirente. In nessun caso, eventuali ritardi nell'assolvimento degli Oneri conferiranno all'Acquirente titolo per risolvere il Contratto e/o per richiedere il risarcimento danni. L'Acquirente rinuncia espressamente a sollevare qualsiasi contestazione, pretesa, eccezione e/o domanda riconvenzionale a tal proposito.

7. Lingua

Le presenti condizioni generali di vendita sono redatte in lingua italiana, da intendersi come unico testo facente fede. Ogni traduzione delle Condizioni Generali di Vendita o ogni altro documento contrattuale formulato in lingua diversa da quella italiana è da intendersi per i soli motivi di cortesia.

8. Foro esclusivamente competente - Rimborso delle spese legali

Per qualsiasi controversia che dovesse insorgere relativamente alla conclusione, applicazione, interpretazione, validità, efficacia, esecuzione e/o risoluzione del Contratto sarà competente in via esclusiva il Tribunale di Treviso (Italia). E' comunque fatta salva la facoltà di AZIENDA di agire in giudizio, anche in via cautelare o provvisoria, avanti al foro del domicilio dell'Acquirente. Per qualsiasi controversia che dovesse insorgere relativamente alla conclusione, applicazione, interpretazione, validità, efficacia, esecuzione e/o risoluzione del Contratto, la parte vittoriosa avrà il diritto di ottenere dalla controparte il rimborso di qualsivoglia costo, spesa e compenso professionale tecnico e/o forense, di misura ragionevole, sostenuto in relazione alla controversia.

9. Legge applicabile

La legge applicabile al Contratto è quella italiana, intendendosi in ogni caso espressamente esclusa l'applicazione al Contratto della Convenzione di Vienna del 11 aprile 1980 sui contratti di vendita internazionale di merci (ad eccezione di quanto previsto all'articolo 11 della Convenzione in merito alla libertà di forma dei contratti, che trova applicazione).

general sales conditions

GENERAL CONDITIONS OF SALE OF AZIENDA S.P.A.

Valid and enforceable starting from 01/01/2017

1. Premise

The following General Conditions of Sale of IDL EXPORT SRL, with registered office in Via San Marco n.2 31050 Fanzolo di Vedelago (TV) in Italy, CF – P IVA 03247000262, (hereinafter called "AZIENDA ") shall govern all sales of products made by AZIENDA (hereinafter "Products") to its clients (hereinafter the "Purchaser"), if not expressly derogated in writing. The General Conditions of Sales supersedes any written or verbal commitment, agreement or covenant previously established between AZIENDA and Purchaser. In no event other conditions of any kind affixed to orders and/or other documents sent by the Purchaser or third parties shall apply without the express written approval of AZIENDA.

2. Entering into the Agreement

Any order placed by the Purchaser will be binding only if made in writing, also by fax or mail. The sale contract shall, therefore, become final and binding only upon receipt by the Purchaser of AZIENDA's written order confirmation, or when AZIENDA commences execution of the order submitted by the Purchaser. Should the order confirmation sent by AZIENDA to the Purchaser contain any modifications with respect to the order, such modifications shall be deemed to have been tacitly accepted by the Purchaser after a 5 (five) working day term of receipt by the latter of such order confirmation, unless the Purchaser gives written notice of disagreement to AZIENDA.

3. Delivery Terms

Unless otherwise agreed in the Agreement, the Products are delivered EXW (Incoterms 2010) to the registered office of AZIENDA in 31050 Fanzolo di Vedelago (TV) Via San Marco n. 2 in Italy (hereinafter referred to as "Delivery"). Unless otherwise agreed in writing, the Purchaser shall collect the products no later than 8 (eight) days. In case of delay in the withdrawal of the Products, the agreed payment terms shall not be extended and the Purchaser shall pay all charges relating to the occupation of the warehouses to AZIENDA amounting to a daily fixed sum of 0,5% of the Products' net price. It is understood that the risk of damage, deterioration, loss and/or theft of the same will be borne by the Purchaser from the initially agreed date of delivery. The Company shall provide the Products with standard packaging suitable for ordinary transportation and handling. Should a special packaging be required, the latter shall be invoiced at cost according to the agreements entered into on a time to time basis with the Purchaser. In no event the delivery terms agreed in the Agreement (hereinafter "Terms of Delivery") shall be considered final terms. Should an advance payment on the order, the opening of a letter of credit or the issuance of a bank guarantee be agreed, delivery terms will start running as of receipt of such advance payment or of the documents confirming the effectiveness of the letter of credit or the bank guarantee. The abovementioned terms shall be suspended until notification by the Purchaser of all technical and administrative data and information necessary for the proper fulfilment of the order. Terms of delivery shall be automatically extended in case the Purchaser request any modification to the order after the sale contract being finalised and shall be automatically suspended in case the Purchaser fail to pay any amount due to AZIENDA even if such failure is not related to the pending order. Any delays in delivery of 30 (thirty) days or less from the agreed or extended delivery term cannot under any circumstances give rise to claims for damages or price reductions, or entitle to cancelling and/or terminating and/or amending the Agreement. In case of late delivery exceeding sixty (60) days, the Purchaser shall be entitled to a daily penalty of EUR 50.00 (fifty/00), effective from the sixty-first day until the actual delivery date; the Purchaser gives up expressly claims for the maximum damage, to claims of reduced prices, to request cancellation and/ or termination and/or amendment of the Agreement. In case of delays in delivery of certain products caused by unforeseeable circumstances, force majeure, to delay or lack in deliveries by its suppliers and/or other causes not attributable to willful misconduct and/or gross negligence or any other cause beyond the reasonable control of AZIENDA, the Purchaser shall not be entitled to claim any compensation and/or damages, nor to require the termination and/or amendment and/or cancellation of the agreement or the price reduction for the furnished products.

4. Price and payment terms

Unless otherwise indicated in the order confirmation, prices of the Products expressed in Euro shall be those set forth in AZIENDA's price list in force at the date of the order confirmation. Payment shall be performed according to the terms indicated by AZIENDA in the order confirmation. However, the Seller shall have the right to increase the price of the Goods at any time before the delivery, in order to cover increases in the cost of the Goods due to any factor beyond the control of the Seller. Products shall remain the sole property of AZIENDA until full payment of the price or full cash of any possible checks, promissory notes, or any other negotiable means of payment have occurred, even if the transport documents have already been delivered. In case of failure to pay even partially the price, AZIENDA shall be entitled to suspend the execution of the Agreement until full payment of the due amounts, or the enforcement of appropriate guarantees. In case of late payment, even partial, AZIENDA will be entitled to the payment of default interests permitted by applicable law (Legislative Decree no. 231/2002, as amended), which in any case will begin to accrue automatically from the due day without need of any default notice. Under no circumstances, any defects of the products, even if expressly recognized by AZIENDA, as well as any delays in meeting the delivery terms, will give the Purchaser the right to suspend the payments, and/or any other payment due to AZIENDA under this Agreement or other contractual relationships (estoppel clause pursuant to art. 1462 cc). 5. Guarantees and claims – returned goods – list/s AZIENDA guarantees the absence of defects in products pursuant to the law. In the event that any complaint of the Purchaser with regard to defects in products proves to be justified and accepted by AZIENDA during the warranty period, AZIENDA will provide free replacement of faulty products and/or, at its sole discretion, their repair with delivery made EXW (Incoterms 2010) at the registered office of AZIENDA. It is understood that the guarantee obligation assumed by AZIENDA is limited to Product defects expressly recognized and accepted by AZIENDA. The Purchaser shall examine each single Product immediately upon receipt. Under penalty of cancellation of the guarantee, the Purchaser must report the defects found in the products in writing. This warranty for the Purchaser only covers defects in material or workmanship of the Products, and applies under normal conditions of usage, transport, storage, maintenance, display and sale. Furthermore, this warranty shall apply only on condition that: 1) the Purchaser is not late in any payment either or not related to the defective Products; 2) the use of the Products is consistent with their technical characteristics and is in compliance and within the limits set forth under the installation instructions; 3) the Products are installed by qualified technicians in compliance with the installation instructions and the technical regulations; 4) the Products are powered with power devices supplied by AZIENDA and, if necessary, installed in the AZIENDA's shuttering; 5) the installation of the Product is certified by the installer in accordance with applicable regulations; 6) the Products have been modified, altered or repaired by third parties not previously authorised by AZIENDA; 7) the defects of the Product are due to unexpected or not reasonably probable events, including electric shocks, lightning or electrostatic discharges; 8) the electrical system is operating in an environment whose characteristics are not compliant with those required for a proper functioning according to the type and destination of the Products, including, by way of example, impulsive line noise, sudden power surges, excessive temperature or insufficient ventilation. In particular, and without prejudice of the generality of the foregoing, the warranty shall not apply to used or second-hand Products, in case of defects of Products caused by inappropriate conditions of storage, transport, custody, maintenance, display or sale by the Purchaser (and/or by third parties) or defects of the Products due to fault of the Purchaser (or of third parties), or failure to comply with the instructions and indications for use provided for by AZIENDA. Purchaser understands and agrees that the information and/or data and/or images and/or terms of products, indicated in the list/s of AZIENDA and/or on the website www.AZIENDA.it and/or other materials for technical and/or commercial and/or promotional, are purely indicative. AZIENDA expressly reserves the right to change, at any time and without notice, specifications, models, materials, colors, accessories, finishes and in general any characteristic of the products reported in the list / s and/or these websites and/or other materials for technical and/or commercial and/or promotional. No returns of Products shall be allowed unless previously approved in writing by AZIENDA. The Purchaser shall, therefore, inform AZIENDA in writing before the Products approved for return are shipped. Returned Products shall always be delivered DDP (Incoterms 2010) AZIENDA.

6. Charges

Any taxes, levies, duties, fees, licenses, authorizations, permits and/or other tax charges and/or Custom duties and/ or administrative expenses however designated, under the laws of the State of importation of products covered by the Agreement (hereinafter then, "Charges"), are entirely and exclusively borne by the Purchaser. No delay in the settlement of such charges shall entitle the Purchaser to terminate the Agreement and/or to claim damages. The Purchaser expressly waives the right to raise any challenge, claim, appeal, objection and/ or counter-claim in this regard.

7. Language

These General Conditions of Sale are written in Italian and shall be understood as the only authentic text. Any translation of these General Conditions of Sale as well as any other contractual documents in any language other than Italian shall be deemed for courtesy purposes only.

8. Exclusive jurisdiction - Reimbursement of legal fees

For any dispute that may arise related to the conclusion, application, interpretation, validity, effectiveness, execution and/or termination of this Agreement will be referred exclusively to the Court of Treviso (Italy). Still AZIENDA has the right to act in justice, as an interim or provisional measure, before the competent court of law of the Purchaser's address. For any dispute that may arise related to the conclusion, application, interpretation, validity, effectiveness, execution and/or termination of this Agreement, the winning party shall be entitled to obtain from the other party the reimbursement of any professional technical and/or forensic costs, expenses and compensation, to a reasonable extent, incurred in relation to the dispute.

9. Applicable Law

The law applicable to the Agreement is Italian, being expressly excluded the application to the Agreement of the Vienna Convention of April 11, 1980 on the International Sale of Goods being hereby expressly excluded (with the exception of art. 11 thereof regarding the agreements' freedom of forms, which shall apply).



IDL EXPORT s.r.l.

via S. Marco, 14
31050 Fanzolo di Veduggio
Treviso - Italy

T +39 0423 487141
F +39 0423 476206

info@idlexport.it
www.idl1987.it

Concept & Direction: IDL marketing department

Project Coordinator: Davide Cillotto

Photography: Emanuele Surian / Fisheye Massino Pesce / Quasar / Studio Visus

Bank Images: iStockphoto.com / unplash.com / pexels.com / midjourney.com

Lithography & Printing: XXXXXXXXXXXX

Finished printing: February 2024

È vietata la riproduzione anche parziale di questo catalogo.

IDL si riserva il diritto di apportare modifiche e/o migliorieai prodotti illustrati nel presente catalogo senza alcunobbligodipreavviso. Tutela sui diritti d'autore, legge 22/4/1941n°633, legge 14/12/1942n°1485. Proibita ogni riproduzione anche parziale.

It is forbidden to reproduce any part of this catalogue.

IDL reserves the right to make changes and/or improvements to the products described in this catalog without prior notice. Safeguarded by the law on copyright

idl1987.it